

POMPE A MEMBRANA - DIAPHRAGM PUMPS

STRIP- MINIPOLY

STRIP
MINIPOLY Pag. 6

NPR 20
PBP 25
KARIN Pag. 7 - 8
KIT accessori comando a distanza - Remote mounting kits - Accessori - Accessories

CHEMICAL POLYPUMPS (15 bar)

Pompe POLY - POLY Pumps Pag. 9 - 14

POMPE MEDIA / ALTA PRESSIONE — MEDIUM / HIGH PRESSURE PUMPS (40 – 50 BAR)

PPS
PA PAG. 16 - 23
PBO
IDB

POMPE A PISTONI - PISTON PUMPS

C SERIES
CKA SERIES Pag. 24 - 25
CX SERIES

MOTOPOMPE e ELETROPOMPE - POWER SPRAYER UNITS

Elettropompe 12 VOLT - 12 VOLT Electric Pumps Pag. 26
Motopompe, Elettropompe - Petrol engine driven pumps, Electric motor driven pumps Pag. 27 - 28
Pompe con motore idraulico - Hydraulic motor pumps Pag. 29

REGOLATORI DI PRESSIONE - PRESSURE REGULATORS

KARIN - STING - STING PLUS - MOBY - VS

KARIN
STING
STING PLUS
VRP 85 Pag. 30 - 31
MOBY
VS

Accessori di collegamento - Accessories and parts to connect pumps with pressure regulator

MULTIDUPLO
VIG Pag. 32

ACCESSORI - ACCESSORIES

RIDUTTORI - GEARBOXES

Riduttori - Gearboxes PAG. 34

ACCESSORI DI AZIONAMENTO - DRIVE ACCESSORIES

Giunti per motori idraulici - Hydraulic motor couplings Pag. 34
Flange per moltiplicatore - Overgear Flanges

ACCESSORI — ACCESSORIES

Dispositivi di sicurezza - Safety accessories	Pag. 35
Filtri aspirazione — Suction filters	Pag. 37 - 42
Accessori — Accessories	PAG. 43
Filtri in linea e accessori - Line filters and accessories	Pag. 44
Pistole, Lance e Ugelli - Spray Guns, Lances and Nozzles	Pag. 45 - 46

SISTEMI DI COMANDO SERIE S5 - T5



Schemi di composizione serie S5 e T5 - Series S5 and T5 composition schemes	Pag. 48 - 49
Valvole di sezione - Section valves	Pag. 50 - 53
Filtri e flussometri - Filters and flowmeters	Pag. 53
Valvole di regolazione e di sezione - Regulating valves and section valves	Pag. 54
Raccordi e accessori di completamento - Fittings kits and complementary accessories	Pag. 54 - 55
Manometri - Pressure gauges	Pag. 56
Gruppi di regolazione - Regulating Units	Pag. 57 - 58
Gruppi valvole di sezione - Section valves assemblies	Pag. 59
Valvole TRIM — TRIM manifolds	Pag. 60
Raccordi di completamento - Optional extra	Pag. 61 - 62

ECOCONTROL HP

Distributori 40 Bar motorizzati - 40 Bar motor powered control units	
Gruppi di regolazione - Regulating Units	Pag. 63
Valvole di sezione — Section valves	

VIKING HP

Distributori manuali e motorizzati HP — Manual and motor powered units HP	
Gruppi regolazione — Regulating units	Pag. 64
Valvole di sezione - Section valves	

ACCESSORI - ACCESSORIES

Kit portagomma - Hose tails kit	
Manometri - Pressure gauges	Pag. 64 - 65

VALVOLE A SFERA SUSY - SUSY BALL VALVES

Unità e valvole generali di chiusura - Shutoff valves and units	Pag. 66 - 67
---	--------------

AG. CONTROL SYSTEMS

COMPUTER WSC GPS	Pag. 68
COMPUTER HYDRAULIC WSC GPS	Pag. 70
COMPUTER SBSC	Pag. 71 - 74
COMPUTER BUONO Simply	Pag. 75
COMPUTER HYDRAULIC BUONO SIMPLY	Pag. 76
BERTY CONTROL	Pag. 77 - 78
PANEL CONTROL	Pag. 77 - 78
PRESSURE PANEL CONTROL	Pag. 77 - 78
HYDRAULIC PANEL CONTROL	Pag. 77 - 78
MANOMETRO ANALOGICO - ANALOG PRESSURE GAUGE	Pag. 78
Accessori per Computer - Computer accessories	Pag. 79
Valvole Pre-Set - Pre-Set Valves	Pag. 80 - 82

ECOCONTROL LP

Distributori manuali e motorizzati - Manual and motor powered control units	Pag. 83
Kit raccordi - Pipe fittings kits	

MULTICONTROL

Distributori manuali e motorizzati - Manual and motor powered control units	Pag. 84
Kit raccordi - Pipe fittings kits	

NERGYDROP - FILL NERGYDROP

Distributori manuali e motorizzati - Manual and motor powered control units	Pag. 85 - 86
Fill Nergydrop manuali e motorizzati - Manual and motor powered Fill Nergydrop	
Kit raccordi ingresso e by-pass - Inlet and outlet pipe fittings kits	

VIKING LP

NEW

Gruppi regolazione Motorizzati Viking LP - Motor powered regulating units Viking LP	Pag. 87
Set valvole di sezione Motorizzate - Motor powered section valves assy	
Kit raccordi - Outlets Kit	

GRUPPI SERIE 5 ASSEMBLATI — ASSEMBLED 5-SERIES UNITS

NEW

Gruppi Serie 5 Assemblati — Assembled units Series 5	Pag. 88
Versioni Speciali	Pag. 89
Imballi	Pag. 90

CONDIZIONI DI FORNITURA TERMS OF SALE

ITALIA

RESA DELLA MERCE:	FRANCO NOSTRO STABILIMENTO
I.V.A.:	ESCLUSA
IMBALLO:	AL COSTO, COME DA LISTINO IN VIGORE

EXPORT

DELIVERY TERMS:	EX-WORKS
PACKING:	AT COST, ACCORDING TO THE PRICE LIST IN FORCE

IL PRESENTE LISTINO ANNULLA E SOSTITUISCE TUTTI I PRECEDENTI E PUÒ ESSERE MODIFICATO SENZA ALCUN PREAVVISO.
IDROMECCANICA BERTOLINI SI RISERVA IL DIRITTO DI CORREGGERE ERRORI DI STAMPA.

THIS PRICE LIST CANCELS ALL PREVIOUS ONES AND CAN BE MODIFIED WITHOUT NOTICE.
IDROMECCANICA BERTOLINI RESERVES THE RIGHT TO RECTIFY MISPRINTS.

IDROMECCANICA BERTOLINI S.p.A.
LISTINO PREZZI: POMPE ED ACCESSORI AGRICOLTURA
01/12/2022

IDROMECCANICA BERTOLINI S.p.A.
PRICE LIST: AGRICULTURE PUMPS AND ACCESSORIES
01/12/2022



INDICE VERSIONI SHAFTS VERSIONS

CV	CON VALVOLA REGOLAZIONE PRESSIONE WITH PRESSURE REGULATOR	
SV	SENZA VALVOLA REGOLAZIONE PRESSIONE WITHOUT PRESSURE REGULATOR	
VF	ALBERO STANDARD 6 FORI STANDARD 6 HOLES SOLID SHAFT	
VS	ALBERO STANDARD 1"3/8 SCANALATO MASCHIO POSTERIORE REAR. STANDARD SPLINE SHAFT 1"3/8	
VA	ALBERO CILINDRICO Ø 3/4" - Ø 1" SOLID SHAFT Ø 3/4 - Ø 1"	
VC	ALBERO PASSANTE 1"3/8 SCANALATO MASCHIO ANTERIORE - 6 FORI POSTERIORE FRONT: MALE SPLINE THRU SHAFT 1"3/8 - REAR: 6 HOLES	
VC1	ALBERO PASSANTE 1"3/8 SCANALATO MASCHIO ANTERIORE - ALBERO CAVO Ø1" - 25 mm POSTERIORE FRONT: MALE SPLINE THRU SHAFT 1"3/8 - REAR: HOLLOW SHAFT Ø 1" - 25 mm	
VC2	ALBERO PASSANTE ANTERIORE E POSTERIORE CAVO Ø 1" - 25 mm HOLLOW THRU SHAFT Ø 1"	
VD	ALBERO PASSANTE 1"3/8 SCANALATO MASCHIO ANT. E POST. MALE SPLINE THRU SHAFT 1"3/8	
VDA	ALBERO PASSANTE 1"3/8 MASCHIO ANTERIORE - CILINDRICO Ø 1" POSTERIORE FRONT: MALE SPLINE THRU SHAFT 1" 3/8 - REAR: SOLID SHAFT Ø 1"	
VDE	ALBERO PASSANTE 1"3/8 MASCHIO ANTERIORE - CILINDRICO Ø 25 MM POSTERIORE FRONT: MALE SPLINE THRU SHAFT 1" 3/8 - REAR: SOLID SHAFT Ø 25 MM	
VM	ALBERO PASSANTE 1"3/8 SCANALATO MASCHIO ANTERIORE - 1"3/8 SCANALATO FEMMINA - 6 FORI POSTERIORE FRONT: MALE SPLINE THRU SHAFT 1"3/8 - REAR: FEMALE SPLINE THRU SHAFT 1"3/8 - 6 HOLES	
MF	ALBERO PASSANTE 1"3/8 SCANALATO MASCHIO ANTERIORE - 1"3/8 SCANALATO FEMMINA FRONT: MALE SPLINE THRU SHAFT 1"3/8 - REAR: FEMALE SPLINE THRU SHAFT 1"3/8	
VP	ALBERO CILINDRICO POSTERIORE Ø 35 mm. REAR: SOLID SHAFT Ø 35 MM.	
VP 1	ALBERO PASSANTE CILINDRICO Ø 25 mm. ANTERIORE - 3 FORI POSTERIORE FRONT: SOLID THRU SHAFT Ø 25 MM - REAR: 3 HOLES	
VI	ALBERO CAVO Ø 1" - Ø 25 mm HOLLOW SHAFT Ø 1" - Ø 25 mm	
RT4	POMPA PREDISPOSTA PER MOTORI A SCOPPIO 4 TEMPI PUMP FOR COUPLING TO 4 STROKE PETROL ENGINE	
DE-D	POMPA PREDISPOSTA PER MOTORI ELETTRICI COMMERCIALI O SPECIALI BERTOLINI PUMP FOR COUPLING TO COMMERCIAL ELECTRIC MOTOR (OR SPECIAL VERSION BERTOLINI)	
RTE.1	POMPA PREDISPOSTA PER MOTORI ELETTRICI O TERMICI CON RIDUTTORE AD 1 STADIO PUMP FOR COUPLING TO ELECTRIC MOTOR OR PETROL ENGINES WITH FIXED RATIO GEARBOXES	

20
BAR

LOW PRESSURE
DIAPHRAGM PUMPS



STRIP - MINIPOLY



STRIP		VERSIONE CON REGOLATORE PBP 25 VERSION WITH PRESSURE REGULATOR PBP 25			STRIP			VERSIONE CON REGOLATORE NPR 20 VERSION WITH PRESSURE REGULATOR NPR 20		
STRIP VA 3/4"	STRIP DE (MEC 80)	STRIP DT4 (Vers. SAE 3/4")	STRIP DT4 (Vers. Q 5/8")	STRIP DT4 (Vers. S 15mm)	STRIP DE (MEC 80)	STRIP D (MEC 71)	STRIP DT4 (Vers. S)			
117000973 349,25 €	117001973 343,44 €	117005973 349,25 €	117004973 349,25 €	117003973 349,25 €	117017973 287,69 €	117018973 271,89 €	117019973 306,31 €			

NEW DURAMAX
MEMBRANE



MINIPOLY 2020 HP			VERSIONE PER REGOLATORE NPR 20 O PBP 25 VERSION FOR PRESSURE REGULATOR NPR 20 OR PBP 25		
POLY 2020.1 VF HP (SV)	POLY 2020.1 VA HP (SV)	POLY 2020.1 RTE HP (SV)	POLY 2020.1 RT4.1 SAE 3/4" HP (SV)	POLY 2020.1 RT4.1 Q 5/8" HP (SV)	POLY 2020.1 RT4.1 S (15mm) HP (SV)
94852797ADS 415,00 €	94852897ADS 398,00 €	94855397ADS 386,10 €	94855097ADS 484,65 €	94855197ADS 484,65 €	94855297ADS 484,65 €

NEW DURAMAX
MEMBRANE



MINIPOLY 2025 HP		VERSIONE PER REGOLATORE NPR 20 O PBP 25 VERSION FOR PRESSURE REGULATOR NPR 20 OR PBP 25			
POLY 2025.1 VF HP (SV)	POLY 2025.1 RTE.1 HP (SV)	POLY 2025.1 RT4.1 SAE 3/4" HP (SV)	POLY 2025.1 RT4.1 Q 5/8" HP (SV)	POLY 2025.1 RT4.1 S (15mm) HP (SV)	
94861397ADS 429,30 €	94865097ADS 403,65 €	94865197ADS 523,80 €	94865297ADS 523,80 €	94865397ADS 523,80 €	

MINIPOLY 2030			VERSIONE PER REGOLATORE KARIN VERSION FOR PRESSURE REGULATOR KARIN		
POLY 2030.1 VF (SV)	POLY 2030.1 VA (SV)	POLY 2030.1 RTE (SV)	POLY 2030.1 RT4.1 SAE 3/4" (SV)	POLY 2030.1 RT4.1 Q 5/8" (SV)	POLY 2030.1 RT4.1 S (15mm) (SV)
94741197ADS 464,40 €	94740197ADS 430,65 €	94745197ADS 421,20 €	94742197ADS 567,00 €	94743197ADS 567,00 €	94744197ADS 567,00 €

20
BARLOW PRESSURE
DIAPHRAGM PUMPS**BERTOLINI**
pumps

STRIP - MINIPOLY

VALVOLE DI REGOLAZIONE PRESSIONE - PRESSURE REGULATORS



MODELLO MODEL	CODICE PART NR.	PREZZO PRICE	MODELLI POMPE PUMPS MODELS
NPR STRIP	119835973	51,30 €	STRIP
NPR 20	949845973	51,30 €	POLY 2020 POLY 2025



MODELLO MODEL	CODICE PART NR.	PREZZO PRICE	MODELLI POMPE PUMPS MODELS	NOTE
P.B.P. 25	947300973	75,60 €	STRIP POLY 2020 - 2025	SENZA MANOMETRO WITHOUT PRESSURE GAUGE
P.B.P. 25	947301973	99,90 €	STRIP POLY 2020 - 2025	CON MANOMETRO WITH PRESSURE GAUGE
P.B.P. 10 BAR	947302973	72,90 €	STRIP POLY 2020 - 2025	SENZA MANOMETRO WITHOUT PRESSURE GAUGE
P.B.P. 10 BAR	947303973	94,50 €	STRIP POLY 2020 - 2025	CON MANOMETRO WITH PRESSURE GAUGE



MODELLO MODEL	CODICE PART NR.	PREZZO PRICE	MODELLI POMPE PUMPS MODELS	NOTE
KARIN 2 VIE KARIN 2 WAYS	244011973	112,05 €	POLY 2030	CON MANOMETRO WITH PRESSURE GAUGE
	24401197PP (polipropilene)	99,90 €		

20
BAR

KIT ACCESSORI COMANDO A DISTANZA - REMOTE MOUNTING KITS



DESCRIZIONE - DESCRIPTION	VALVOLA REGOLAZIONE PRESSURE REGULATOR	CODICE PART NR.	PREZZO PRICE
KIT ACCESSORI ORIENTABILI 1/2" REMOTE ADJUSTABLE KIT 1/2"	KARIN	318911973	33,75 €
KIT ACCESSORI Ø 13 - REMOTE KIT Ø 13	NPR 20 - P.B.P 25	318974973	28,35 €
KIT MANDATA POMPA Ø 13 PUMP PRESSURE CONNECTOR KIT Ø 13	MINIPOLY 2020 - 2025 SV (VERS. NPR 20 - P.B.P 25)	318975973	17,55 €
KIT MANDATA POMPA 1/2" PUMP PRESSURE CONNECTOR KIT 1/2"	POLY 2030 SV	318916973	17,55 €

20
BAR

LOW PRESSURE
DIAPHRAGM PUMPS

BERTOLINI
pumps

ACCESSORI PER POMPE VF - ACCESSORIES FOR PUMPS VF version



DESCRIZIONE DESCRIPTION	CODICE PART NR.	PREZZO PRICE
PULEGGIA 2A ø 250 PULLEY 2A ø 250	310255973	67,50 €
PULEGGIA 2A ø 350 PULLEY 2A ø 350	318933973	256,50 €



DESCRIZIONE DESCRIPTION	CODICE PART NR.	PREZZO PRICE
ATTACCO RAPIDO RIGIDO QUICK RIGID COUPLING	310325973	112,05 €



DESCRIZIONE DESCRIPTION	CODICE PART NR.	PREZZO PRICE
ATTACCO RAPIDO CATENA QUICK CHAIN COUPLING	318343973	152,55 €



DESCRIZIONE DESCRIPTION	CODICE PART NR.	PREZZO PRICE
KIT ALBERO SCANALATO 1"3/8 SPLINE SHAFT 1"3/8 KIT	310049973	51,30 €



DESCRIZIONE DESCRIPTION	CODICE PART NR.	PREZZO PRICE
KIT ALBERO CILINDRICO 3/4" SOLID SHAFT 3/4" KIT	318793973	58,05 €
KIT ALBERO CILINDRICO 1" SOLID SHAFT 1" KIT	318590973	68,85 €

15
BARLOW PRESSURE
DIAPHRAGM PUMPS**BERTOLINI**
pumps

CHEMICAL POLYPUMPS

NEW DURAMAX
MEMBRANE

Poly 550

POMPA STD STD PUMP Mod. 2073 VS disponibile in Versione ECO solo per quantità Mod. 2073 VS available in ECO Version only for quantities	POLY 550 MF	POLY 550 VP	POLY 550 VC	POLY 550 VI	POLY 550 VS	POLY 550 VF
	222000973 CONSULTAR	222001973 CONSULTAR	222003973 CONSULTAR	222004973 CONSULTAR	222005973 CONSULTAR	222006973 CONSULTAR
ACCESSORI ACCESSORIES						
PULEGGIA PULLEY	2A Ø 250 310255973 67,50 € 2A Ø 310 318671973 163,35 € 2A Ø 350 318933973 256,50 € 2A Ø 400 319210973 consultar					
CUFFIA DI PROTEZIONE ANTERIORE FRONT SAFETY CONE	311482322 17,01 €					
CUFFIA DI PROTEZIONE POSTERIORE REAR SAFETY CONE	311482322 17,01 €					
VALVOLA DI SICUREZZA SAFETY VALVE	15 BAR 243200973					
KIT SERBATOIO OLIO A DISTANZA REMOTE MOUNTED OIL TANK	239823973 66,15 €					
DISTRIBUTORI CONTROL UNITS	PAG. 48 - 65	PAG. 48 - 65	PAG. 48 - 65	PAG. 48 - 65	PAG. 48 - 65	PAG. 48 - 65
RIDUTTORI GEARBOXES		PAG. 34	PAG. 34	PAG. 34		
ACCESSORI CONTROLLO OLIO OIL CONTROL ACCESSORIES	PAG. 16	PAG. 16	PAG. 16	PAG. 16	PAG. 16	PAG. 16

15
BARLOW PRESSURE
DIAPHRAGM PUMPS**BERTOLINI**
pumps

CHEMICAL POLYPUMPS

NEW DURAMAX
MEMBRANE

Poly 2073

POMPA STD STD PUMP Mod. 2073 VS disponibile in Versione ECO solo per quantità Mod. 2073 VS available in ECO Version only for quantities	POLY 2073 VS SV	POLY 2073 VP SV	POLY 2073 VA SV	POLY 2073 VDE SV	POLY 2073 VM SV	POLY 2073 VI 1" SV
	635000973DS 616,95 €	635100973DS 616,95 €	635200973DS 616,95 €	635250973DS 664,20 €	635261973DS 762,75 €	635263973DS 734,30 €
ACCESSORI ACCESSORIES						POLY 2073 VI 25mm SV 635265973DS 734,30 €
PULEGGIA PULLEY	2A Ø 250 318843973 252,45 € 3A Ø 310 318463973 271,35 €	3A Ø 310 318672973 172,80 €				
ATTACCO RAPIDO RIGIDO QUICK RIGID COUPLING	318758973 113,40 €					
ATTACCO RAPIDO A CATENA QUICK CHAIN COUPLING	318086973 151,20 €					
CUFFIA DI PROTEZIONE ANTERIORE FRONT SAFETY CONE	311468322 12,29 €					
CUFFIA DI PROTEZIONE POSTERIORE REAR SAFETY CONE				311799322 17,10 €	311799322 17,10 €	
VALVOLA DI SICUREZZA SAFETY VALVE	VEDI PAG. 36 - SEE PAG. 36					
KIT SERBATOIO OLIO A DISTANZA REMOTE MOUNTED OIL TANK	239823973 66,15 €					
DISTRIBUTORI CONTROL UNITS	PAG. 48 - 65	PAG. 48 - 65	PAG. 48 - 65	PAG. 48 - 65	PAG. 48 - 65	PAG. 48 - 65
RIDUTTORI GEARBOXES		PAG. 34	PAG. 34	PAG. 34		
ACCESSORI CONTROLLO OLIO OIL CONTROL ACCESSORIES	PAG. 16	PAG. 16	PAG. 16	PAG. 16	PAG. 16	PAG. 16
BASE CONVERSIONE POMPE COMET CONVERSION MOUNTING RAILS FOR COMET PUMPS	630123612 consultar					

VERSIONE PER ACCOPPIAMENTO A MOLTIPLICATORE
VERSION FOR MOUNTING WITH OVERGEAR

MODELLO - MODEL	CODICE - PART NR.	PREZZO - PRICE
POLY 2073 VM VERSIONE INTEGRATA MOLTIPLICATORE BIMA POLY 2073 VM FOR BIMA OVERGEAR (BUILT IN)	635260973	consultar
POLY 2073 VM VERSIONE INTEGRATA MOLTIPLICATORE CMV POLY 2073 VM FOR CMV OVERGEAR (BUILT IN)	63526297A	558,60 €

15
BAR

LOW PRESSURE
DIAPHRAGM PUMPS



CHEMICAL POLYPUMPS



Poly 2085



Poly 2105

POMPA STD STD PUMP	POLY 2085 VS SV	POLY 2085 VP SV	POLY 2085 VA SV	POLY 2085 VDE SV	POLY 2085 VM SV	POLY 2085 VI 1" SV	POLY 2105 VS SV
	634000973DS 650,70 €	634001973DS 650,70 €	634002973DS 650,70 €	634003973DS 703,35 €	634004973DS 850,50 €	634005973DS 769,50 €	
ACCESSORI ACCESSORIES						POLY 2085 VI 25mm SV 634006973DS 769,50 €	
PULEGGIA PULLEY	2A Ø 250 318843973 252,45 € 3A Ø 310 318463973 271,35 €	3A Ø 310 318672973 172,80 €					2A Ø 250 318843973 252,45 € 3A Ø 310 318463973 271,35 €
CUFFIA DI PROTEZIONE ANTERIORE E POSTERIORE FRONT AND REAR SAFETY CONE	311468322 12,29 €				311799322 17,01 €		311468322 12,29 €
VALVOLA DI SICUREZZA SAFETY VALVE	VEDI PAG. 36 - SEE PAG. 36						
KIT SERBATOIO OLIO A DISTANZA REMOTE MOUNTED OIL TANK	239823973 66,15 €						
DISTRIBUTORI CONTROL UNITS	PAG. 48 - 65	PAG. 48 - 65	PAG. 48 - 65	PAG. 48 - 65	PAG. 48 - 65	PAG. 48 - 65	PAG. 48 - 65
RIDUTTORI GEARBOXES		PAG. 34	PAG. 34	PAG. 34			PAG. 34
ACCESSORI CONTROLLO OLIO OIL CONTROL ACCESSORIES	PAG. 16	PAG. 16	PAG. 16	PAG. 16	PAG. 16	PAG. 16	PAG. 16

15
BARLOW PRESSURE
DIAPHRAGM PUMPS**BERTOLINI**
pumps

CHEMICAL POLYPUMPS

NEW DURAMAX
MEMBRANE

Poly 2120

ACCESSORI ACCESSORIES	POMPA STD STD PUMP Mod. 2120 VS disponibile in Versione ECO Solo per quantità Mod. 2120 VS available in ECO Version only for quantities	POLY 2120 VS SV 626050973DS 834,30 €	POLY 2120 VA SV 626053973DS 866,70 €	POLY 2120 VDA SV 626051973DS 913,95 €	POLY 2120 VD SV 626052973DS 885,60 €	POLY 2120 VC 1" SV 626055973DS 1017,90 €	POLY 2120 VC 25mm SV 626059973DS 1017,90 €
PULEGGIA PULLEY		2A Ø 250 318843973 252,45 € 3A Ø 310 318463973 271,35 €	2A Ø 250 318907973 110,70 €	2A Ø 250 318907973 110,70 €	2A Ø 250 318843973 252,45 € 3A Ø 310 318463973 271,35 €		
CUFFIA DI PROTEZIONE ANTERIORE E POSTERIORE FRONT AND REAR SAFETY CONE		311482322 17,01 €				311482322 17,01 €	
VALVOLA DI SICUREZZA SAFETY VALVE		VEDI PAG. 36 - SEE PAG. 36					
KIT SERBATOIO OLIO A DISTANZA REMOTE MOUNTED OIL TANK		239823973 66,15 €					
DISTRIBUTORI CONTROL UNITS		PAG. 48 - 65	PAG. 48 - 65	PAG. 48 - 65	PAG. 48 - 65	PAG. 48 - 65	PAG. 48 - 65
RIDUTTORI GEARBOXES			PAG. 34				
ACCESSORI CONTROLLO OLIO OIL CONTROL ACCESSORIES		PAG. 16	PAG. 16	PAG. 16	PAG. 16	PAG. 16	PAG. 16

**GIUNTI SCANALATI FEMMINA 1" 3/8 PER L'ACCOPIAMENTO DELLE POMPE IN TANDEM
FEMALE SPLINE COUPLINGS 1"3/8 TO DRIVE TWIN PUMPS (POLYPUMPS SERIES)**

DESCRIZIONE - DESCRIPTION	CODICE - PART NUMBER	PREZZO - PRICE
GIUNTO SCANALATO A MORSETTO L=80 mm SPLINE COUPLING (SELF LOCKING) L=80 mm	319147973	CONSULTAR
GIUNTO SCANALATO A MORSETTO L=130 mm SPLINE COUPLING (SELF LOCKING) L=130 mm	318772972	CONSULTAR
PROTEZIONE - SAFETY GUARD (POLY 2180-2210-2240-2260-2300-2400)	280079612	CONSULTAR

15
BARLOW PRESSURE
DIAPHRAGM PUMPSBERTOLINI
pumps

CHEMICAL POLYPUMPS



Poly 2150



Poly 2180

ACCESSORI ACCESSORIES	POMPA STD STD PUMP Mod. 2150 VS disponibile in Versione ECO solo per quantità. Mod. 2150 VS available in ECO Version only for quantities	POLY 2150 VS SV	POLY 2150 VA SV	POLY 2150 VDA SV	POLY 2150 VD SV	POLY 2150 VC 1" SV	POLY 2180 VD SV	POLY 2180 VS SV	POLY 2180 VC 1" SV	
		626117973DS 861,30 €	626121973DS 886,95 €	626118973DS 938,25 €	626119973DS 907,20 €	626130973DS 1044,90 €	289220973DS 1308,15 €	289272973DS 1290,60 €	289267973DS 1498,50 €	
		2A Ø 250 318843973 252,45 €	2A Ø 250 318907973 110,70 €	2A Ø 250 318907973 110,70 €	2A Ø 250 318908973 159,30 €		2A Ø 250 318908973 159,30 €	2A Ø 250 318908973 159,30 €		
		3A Ø 310 318463973 271,35 €			3A Ø 310 318463973 271,35 €		3A Ø 310 318463973 271,35 €	3A Ø 310 318463973 271,35 €		
		311482322 17,01 €		311482322 17,01 €	311482322 17,01 €	311482322 17,01 €	311482322 17,01 €		311482322 17,01 €	
							280079612 consultar			
		VEDI PAG. 36 - SEE PAG. 36								
		239823973 66,15 €				23982497A 133,65 €				
							318898973 17,55 €			
		PAG. 48 - 65	PAG. 48 - 65	PAG. 48 - 65	PAG. 48 - 65	PAG. 48 - 65	PAG. 48 - 65	PAG. 48 - 65	PAG. 48 - 65	
		PAG. 16	PAG. 16	PAG. 16	PAG. 16	PAG. 16	PAG. 16	PAG. 16	PAG. 16	

GIUNTI SCANALATI FEMMINA 1" 3/8 PER L'ACCOPIAMENTO DELLE POMPE IN TANDEM
FEMALE SPLINE COUPLINGS 1"3/8 TO DRIVE TWIN PUMPS (POLYPUMPS SERIES)

DESCRIZIONE - DESCRIPTION	CODICE - PART NUMBER	PREZZO - PRICE
GIUNTO SCANALATO A MORSETTO L=80 mm SPLINE COUPLING (SELF LOCKING) L=80 mm	319147973	consultar
GIUNTO SCANALATO A MORSETTO L=130 mm SPLINE COUPLING (SELF LOCKING) L=130 mm	318772972	consultar
PROTEZIONE - SAFETY GUARD (POLY 2180-2210-2240-2260-2300-2400)	280079612	consultar

15
BARLOW PRESSURE
DIAPHRAGM PUMPS**BERTOLINI**
pumps

CHEMICAL POLYPUMPS

NEW DURAMAX
MEMBRANE

Poly 2210-2240

POMPA STD STD PUMP	POLY 2210 VD SV	POLY 2210 VM SV	POLY 2210 VC 1"3/8 SV	POLY 2210 VC2 1"3/8 SV	POLY 2240 VD SV	POLY 2240 VM SV	POLY 2240 VC 1"SV	POLY 2240 VC2 1" SV
			556015973DS 1958,85 €	556016973DS 2018,25 €			557002973DS 1977,75 €	557003973DS 2034,45 €
ACCESSORI ACCESSORIES	556000973DS 1750,95 €	556002973DS 1958,85 €	POLY 2210 VC 25mm SV 556025973DS 1958,85 €	POLY 2210 VC2 25mm SV 556026973DS 1958,85 €	557000973DS 1773,90 €	557001973DS 1958,85 €	POLY 2240 VC 25mm SV 557007973DS 2034,45 €	POLY 2240 VC2 25mm SV 557008973DS 2034,45 €
PULEGGIA PULLEY	3A Ø 310 318463973 271,35 €				3A Ø 310 318463973 271,35 €			
CUFFIA DI PROTEZIONE ANTERIORE E POSTERIORE FRONT AND REAR SAFETY CONE		311482322 17,01 €				311482322 17,01 €		
VALVOLA DI SICUREZZA SAFETY VALVE	VEDI PAG. 36 - SEE PAG. 36							
PROTEZIONE P.D.F. P.T.O. COVER	318898973 17,55 €				318898973 17,55 €			
KIT SERBATOIO OLIO A DISTANZA REMOTE MOUNTED OIL TANK	239823973 66,15 €							
DISTRIBUTORI CONTROL UNITS	PAG. 48 - 65	PAG. 48 - 65	PAG. 48 - 65	PAG. 48 - 65	PAG. 48 - 65	PAG. 48 - 65	PAG. 48 - 65	PAG. 48 - 65
ACCESSORI CONTROLLO OLIO OIL CONTROL ACCESSORIES	PAG. 16	PAG. 16	PAG. 16	PAG. 16	PAG. 16	PAG. 16	PAG. 16	PAG. 16

**GIUNTI SCANALATI FEMMINA 1" 3/8 PER L'ACCOUPLAMENTO DELLE POMPE IN TANDEM
FEMALE SPLINE COUPLINGS 1"3/8 TO DRIVE TWIN PUMPS (POLYPUMPS SERIES)**

DESCRIZIONE - DESCRIPTION	CODICE - PART NUMBER	PREZZO - PRICE
GIUNTO SCANALATO A MORSETTO L=80 mm SPLINE COUPLING (SELF LOCKING) L=80 mm	319147973	consultar
GIUNTO SCANALATO A MORSETTO L=130 mm SPLINE COUPLING (SELF LOCKING) L=130 mm	318772972	consultar
PROTEZIONE - SAFETY GUARD (POLY 2180-2210-2240-2260-2300-2400)	280079612	consultar

15
BAR

LOW PRESSURE
DIAPHRAGM PUMPS



CHEMICAL POLYPUMPS

NEW DURAMAX
MEMBRANE



Poly 2260 — 2300



Poly 2400.1

POMPA STD STD PUMP	POLY 2260 VD SV	POLY 2260 VM SV	POLY 2260 VC 1" SV	POLY 2260 VC2 1" SV	POLY 2300 VD SV	POLY 2300 VM SV	POLY 2300 VC 1" SV	POLY 2300 VC2 1" SV	POLY 2400.1 VD 15105097ADS 2839,05 €
	146013973DS 1910,25 €	146038973DS 2139,75 €	146041973DS 2282,85 €	146042973DS 2354,40 €			146031973DS 2343,60 €	146068973DS 2343,60 €	CONSULTAR
ACCESSORI ACCESSORIES			POLY 2260 VC 25mm SV	POLY 2260 VC2 25mm SV			POLY 2300 VC 25mm SV	POLY 2300 VC2 25mm SV	POLY2400.1 VI 1 151056973DS CONSULTAR
			146066973DS 2343,60 €	146067973DS 2282,85 €	146022973DS 2135,70 €	146039973DS 2343,60 €	146068973DS 2343,60 €	146069973DS 2343,60 €	POLY 2400.1 VI 32mm 151057973DS CONSULTAR
PULEGGIA PULLEY	3A Ø 310 318463973 271,35 €				3A Ø 310 318463973 271,35 €				CONSULTAR 318463973 € 201,00
CUFFIA DI PROTEZIONE ANTERIORE E POSTERIORE FRONT AND REAR SAFETY CONE		311482322 17,01 €				311482322 17,01 €			311482322 17,01 €
VALVOLA DI SICUREZZA SAFETY VALVE	VEDI PAG. 36 - SEE PAG. 36								
PROTEZIONE P.D.F. P.T.O. COVER	318898973 15,55 €				318898973 15,55 €				318898973 15,55 €
KIT SERBATOIO OLIO A DIST. REMOTE MOUNTED OIL TANK	23982497A 133,65 €								
DISTRIBUTORI CONTROL UNITS	PAG. 48 - 65	PAG. 48 - 65	PAG. 48 - 65	PAG. 48 - 65	PAG. 48 - 65	PAG. 48 - 65	PAG. 48 - 65	PAG. 48 - 65	PAG. 48 - 65
ACCESSORI CONTROLLO OLIO OIL CONTROL ACCESSORIES	PAG. 16	PAG. 16	PAG. 16	PAG. 16	PAG. 16	PAG. 16	PAG. 16	PAG. 16	PAG. 16

GIUNTI SCANALATI FEMMINA 1" 3/8 PER L'ACCOPIAMENTO DELLE POMPE IN TANDEM
FEMALE SPLINE COUPLINGS 1"3/8 TO DRIVE TWIN PUMPS (POLYPUMPS SERIES)



DESCRIZIONE - DESCRIPTION	CODICE - PART NUMBER	PREZZO - PRICE
GIUNTO SCANALATO A MORSETTO L=80 mm SPLINE COUPLING (SELF LOCKING) L=80 mm	319147973	77,38 €
GIUNTO SCANALATO A MORSETTO L=130 mm SPLINE COUPLING (SELF LOCKING) L=130 mm	318772972	100,25 €
PROTEZIONE - SAFETY GUARD (POLY 2180-2210-2240-2260-2300-2400)	280079612	85,75 €

40
BARMEDIUM PRESSURE
DIAHPRAGM PUMPSBERTOLINI
pumps

CHEMICAL POLYPUMPS PPS SERIES





PPS 100



PPS 1211

POMPA PUMP	PPS 100 VD SV	PPS 100 MF SV	PPS 100 VP SV	PPS 1211 VD SV	PPS 1211 VM SV	PPS 1211 VP SV
ACCESSORI ACCESSORIES	365000973 1224,45 €	365001973 1274,40 €	365003973 1274,40 €	391050973 1471,50 €	391051973 1529,55 €	391052973 1529,55 €
PULEGGIA PULLEY	3A Ø 310 318463973 271,35 €		3A Ø 310 318672973 172,80 €	3A Ø 310 318463973 271,35 €		
CUFFIA DI PROTEZIONE ANTERIORE FRONT SAFETY CONE	369814973 21,60 €					
CUFFIA DI PROTEZIONE POSTERIORE REAR SAFETY CONE	311482322 17,01 €			311482322 17,01 €		
VALVOLA DI SICUREZZA SAFETY VALVE	VEDI PAG. 36 - SEE PAG. 36					
DISTRIBUTORI CONTROL UNITS	PAG. 48 - 65	PAG. 48 - 65	PAG. 48 - 65	PAG. 48 - 65	PAG. 48 - 65	PAG. 48 - 65
FLANGIA MOLTIPLICATORE OVERGEARS FLANGE		PAG. 34			PAG. 34	
GIUNTO ELASTICO 1" 3/8 GREZZO LATO MOTORE FLEXIBLE COUPLING 1" 3/8 COARSE ENGINE SIDE					318319973 369,90 €	
GIUNTO ELASTICO 1" 3/8 LAVORATO FEMMINA 1" LATO MOTORE FLEXIBLE COUPLING 1" 3/8 MACHINED 1" FEMALE ENGINE SIDE					319117973 383,40 €	
KIT SERBATOIO OLIO A DISTANZA REMOTE MOUNTED OIL TANK	23982497A 133,65 €			239823973 66,15 €		

ACCESSORI CONTROLLO OLIO - OIL CONTROL ACCESSORIES

 	SENSORE LIVELLO OLIO - TAPPO D.56 OIL LEVEL SENSOR WITH CAP D.64	318937973 125,55 €
	SENSORE LIVELLO OLIO - TAPPO D.78 OIL LEVEL SENSOR WITH CAP D.78	318936973 125,55 €
	CONTROLLO REMOTO CON LED E CICALINO DI SEGNALAZIONE REMOTE CONTROL WITH LED AND WARNING BUZZER	828012002 162,00 €

40
BARMEDIUM PRESSURE
DIAHPRAGM PUMPSBERTOLINI
pumps

CHEMICAL POLYPUMPS PPS SERIES



PPS 1212



PPS 1613-1615

POMPA PUMP	PPS 1212 VD SV	PPS 1212 VM SV	PPS 1212 VP SV	PPS 1613 VD SV	PPS 1613 VM SV	PPS 1613 VP SV
	391000973 1517,40 €	391001973 1575,45 €	391002973 1575,45 €	401002973 1942,65 €	401003973 2128,95 €	401004973 2128,95 €
ACCESSORI ACCESSORIES				PPS 1615 VD SV 401052973 2128,95 €	PPS 1615 VM SV 401053973 2520,45 €	PPS 1615 VP SV 401054973 2520,45 €
PULEGGIA PULLEY	3A Ø 310 318463973 271,35 €			3A Ø 310 318463973 271,35 €		
CUFFIA DI PROTEZIONE ANTERIORE FRONT SAFETY CONE	369814973 21,60 €	369814973 21,60 €		369814973 21,60 €	369814973 21,60 €	
CUFFIA DI PROTEZIONE POSTERIORE REAR SAFETY CONE	311482322 17,01 €			311482322 17,01 €		
VALVOLA DI SICUREZZA SAFETY VALVE	VEDI PAG. 36 - SEE PAG. 36					
DISTRIBUTORI CONTROL UNITS	PAG. 48 - 65	PAG. 48 - 65	PAG. 48 - 65	PAG. 48 - 65	PAG. 48 - 65	PAG. 48 - 65
FLANGIA MOLTIPLICATORE OVERGEARS FLANGE		PAG. 35			PAG. 35	
RIDUTTORI PER P.D.F. 1" 3/8 GEARBOXES FOR P.T.O. 1" 3/8						R152 321101973 537,30 €
GIUNTO ELASTICO 1" 3/8 GREZZO LATO MOTORE FLEXIBLE COUPLING 1" 3/8 COARSE ENGINE SIDE						31831997A 369,90 €
GIUNTO ELASTICO 1" 3/8 LAVORATO FEMMINA 1" LATO MOTORE FLEXIBLE COUPLING 1" 3/8 MACHINED 1" FEMALE ENGINE SIDE						319117973 383,40 €
KIT SERBATOIO OLIO A DISTANZA REMOTE MOUNTED OIL TANK		239823973 66,15 €			23982497A 133,65 €	

40
BARMEDIUM PRESSURE
DIAPHRAGM PUMPSBERTOLINI
pumps

PA SERIES

PA 330.1



PA 430.1 - 440



POMPA PUMP	PA330.1 VF SV	PA330.1 VI 25mm SV	PA430.1 VF SV	PA430.1 VI 25mm SV	PA440 VF SV	PA440 VM SV	PA440 VI 25mm SV
ACCESSORI ACCESSORIES	036014973 488,03 €	036020973 488,03 €	037007973 530,96 €	037014973 530,96 €	037020973 572,40 €	037025973 599,67 €	037026973 572,40 €
PULEGGIA PULLEY	2A ø 250 310255973 67,50 € 3A ø 310 318671973 163,35 €		2A ø 250 310255973 67,50 € 3A ø 310 318671973 163,35 €		2A ø 250 310255973 67,50 € 3A ø 310 318671973 163,35 €	2A ø 250 310255973 67,50 € 3A ø 310 318671973 163,35 €	
ATTACCO RAPIDO RIGIDO QUICK RIGID COUPLING	310325973 112,05 €		310325973 112,05 €		310325973 112,05 €	310325973 112,05 €	
ATTACCO RAPIDO A CATENA QUICK CHAIN COUPLING	318343973 152,55 €		318343973 152,55 €		318343973 152,55 €	318343973 152,55 €	
KIT ALBERO SCANALATO 1"3/8 1"3/8 SPLINE SHAFT KIT	310049973 51,30 €		310049973 51,30 €		310049973 51,30 €	318017973 109,35 €	
KIT ALBERO CILINDRICO 1" 1" SOLID SHAFT KIT	318590973 68,85 €		318590973 68,85 €		318590973 68,85 €	318590973 68,85 €	
VALVOLA DI SICUREZZA SAFETY VALVE	PAG. 36						
CUFFIA DI PROTEZIONE POST. REAR SAFETY CONE	311482322 17,01 €						
CUFFIA DI PROTEZIONE ANT. FRONT SAFETY CONE						311467322 12,29 €	
KIT SERBATOIO OLIO A DIST. REMOTE MOUNTED OIL TANK	239823973 66,15 €						
DISTRIBUTORI CONTROL UNITS	PAGG. 48 - 65						
RIDUTTORI GEARBOXES	PAG. 34		PAG. 34		PAG. 34	PAG. 34	
ACCESSORI CONTROLLO OLIO OIL CONTROL ACCESSORIES	PAG. 16						

40
BARMEDIUM PRESSURE
DIAPHRAGM PUMPSBERTOLINI
pumps

PA SERIES

PA 530



PA 730.1



POMPA PUMP	PA530 VF SV	PA530 VS SV	PA530 VI 25mm SV	PA530 VC SV 236005973 662,85 €	PA530 VM SV	PA 730.1 VF SV	PA 730.1 VS SV	PA 730.1 VC SV	PA 730.1 VM SV	PA 730.1 VI 25mm SV	
	236004973 662,85 €	236009973 618,30 €	236034973 662,85 €	PA530/1000 VC 236240973 726,30 €	236006973 676,35 €	237004973 832,95 €	237020973 771,39 €	237000973 832,95 €	237001973 847,26 €	237033973 832,95 €	
ACCESSORI ACCESSORIES											
PULEGGIA PULLEY	2A ø 250 310255973 67,50 € 3A ø 310 318671973 163,35 € 2A ø 350 318933973 256,50 €			2A ø 250 310255973 67,50 € 3A ø 310 318671973 163,35 € 2A ø 350 318933973 256,50 €	2A ø 250 310255973 67,50 € 3A ø 310 318671973 163,35 € 2A ø 350 318933973 256,50 €	2A ø 250 310255973 67,50 € 3A ø 310 318671973 163,35 € 2A ø 350 318933973 256,50 €		2A ø 250 310255973 67,50 € 3A ø 310 318671973 163,35 € 2A ø 350 318933973 256,50 €	2A ø 250 310255973 67,50 € 3A ø 310 318671973 163,35 € 2A ø 350 318933973 256,50 €		
ATTACCO RAPIDO RIGIDO QUICK RIGID COUPLING	310325973 112,05 €		310325973 112,05 €	310325973 112,05 €	310325973 112,05 €	310325973 112,05 €		310325973 112,05 €	310325973 112,05 €		
ATTACCO RAPIDO A CATENA QUICK CHAIN COUPLING	318343973 152,55 €		318343973 152,55 €	318343973 152,55 €	318343973 152,55 €	318343973 152,55 €		318343973 152,55 €	318343973 152,55 €		
KIT ALBERO SCANALATO 1"3/8 1"3/8 SPLINE SHAFT KIT	310049973 51,30 €			310049973 51,30 €	310049973 51,30 €	310049973 51,30 €		310049973 51,30 €	310049973 51,30 €		
KIT ALBERO CILINDRICO 1" 1" SOLID SHAFT KIT	318590973 68,85 €			318590973 68,85 €	318590973 68,85 €	318590973 68,85 €		318590973 68,85 €	318590973 68,85 €		
VALVOLA DI SICUREZZA 40BAR SAFETY VALVE 40BAR	PAG. 36										
KIT VALVOLA SICUREZZA SAFETY VALVE KIT	239833973 47,25 €					239834973 47,25 €					
CUFFIA DI PROTEZIONE POST. REAR SAFETY CONE	311482322 €. 11,70			311482322 17,01 €					311482322 17,01 €		
CUFFIA DI PROTEZIONE ANT. FRONT SAFETY CONE				311467322 12,29 €							
KIT SERBATOIO OLIO A DIST. REMOTE MOUNTED OIL TANK	239823973 66,15 €										
DISTRIBUTORI CONTROL UNITS	PAGG. 48 - 65	PAGG. 48 - 65	PAGG. 48 - 65	PAGG. 48 - 65	PAGG. 48 - 65	PAGG. 48 - 65	PAGG. 48 - 65	PAGG. 48 - 65	PAGG. 48 - 65	PAGG. 48 - 65	
RIDUTTORI GEARBOXES	PAG. 34	PAG. 34		PAG. 34	PAG. 34	PAG. 34		PAG. 34	PAG. 34		
ACCESSORI CONTROLLO OLIO OIL CONTROL ACCESSO- RIES	PAG. 16										

40
BARMEDIUM PRESSURE
DIAPHRAGM PUMPSBERTOLINI
pumps

PA SERIES



PA/S 830 - 930

POMPA PUMP	PA/S 830 VF SV	PA/S 830 VS SV	PA/S 830 VC SV	PA/S 830 VM SV	PA/S 830 VI 25mm SV	PA/S 930 VD SV	PA/S 930 VC SV	PA/S 930 VM SV	PA/S 930 VI 25mm SV
ACCESSORI ACCESSORIES	237552973 974,57 €	237553973 914,49 €	237550973 984,56 €	237551973 1004,67 €	237558973 996,03 €	237510973 993,20 €	237511973 1001,70 €	237512973 1028,97 €	237517973 1001,70 €
PULEGGIA PULLEY	2A ø 250 310255973 67,50 € 3A ø 310 318671973 163,35 € 2A ø 350 318933973 256,50 €		2A ø 250 310255973 67,50 € 3A ø 310 318671973 163,35 € 2A ø 350 318933973 256,50 €	2A ø 250 310255973 67,50 € 3A ø 310 318671973 163,35 € 2A ø 350 318933973 256,50 €		2A ø 250 310255973 67,50 € 3A ø 310 318671973 163,35 € 2A ø 350 318933973 256,50 €	2A ø 250 310255973 67,50 € 3A ø 310 318671973 163,35 € 2A ø 350 318933973 256,50 €	2A ø 250 310255973 67,50 € 3A ø 310 318671973 163,35 € 2A ø 350 318933973 256,50 €	
ATTACCO RAPIDO RIGIDO QUICK RIGID COUPLING	310325973 112,05 €		310325973 112,05 €	310325973 112,05 €		310325973 112,05 €	310325973 112,05 €	310325973 112,05 €	
ATTACCO RAPIDO A CATENA QUICK CHAIN COUPLING	318343973 152,55 €		318343973 152,55 €	318343973 152,55 €		318343973 152,55 €	318343973 152,55 €	318343973 152,55 €	
KIT ALBERO SCANALATO 1"3/8 1"3/8 SPLINE SHAFT KIT	310049973 51,30 €		310049973 51,30 €	310049973 51,30 €		310049973 51,30 €	310049973 51,30 €	310049973 51,30 €	
KIT ALBERO CILINDRICO 1" 1" SOLID SHAFT KIT	318590973 68,85 €		318590973 68,85 €	318590973 68,85 €		318590973 68,85 €	318590973 68,85 €	318590973 68,85 €	
KIT PULEGGIA 2A Ø 80 + ALBERO CILINDRICO 1" PULLEY 2A Ø 80 + 1" SOLID SHAFT	319146973 230,85 €		319146973 230,85 €	319146973 230,85 €		319146973 230,85 €	319146973 230,85 €	319146973 230,85 €	
VALVOLA DI SICUREZZA SAFETY VALVE	PAG. 36								
CUFFIA DI PROTEZIONE ANTER. FRONT SAFETY CONE	311467322 12,29 €								
CUFFIA DI PROTEZIONE POSTER. REAR SAFETY CONE	311482322 17,01 €								
KIT SERBATOIO OLIO A DISTANZA REMOTE MOUNTED OIL TANK	239823973 66,15 €								
DISTRIBUTORI CONTROL UNITS	PAGG. 48 - 65	PAGG. 48 - 65	PAGG. 48 - 65	PAGG. 48 - 65	PAGG. 48 - 65	PAGG. 48 - 65	PAGG. 48 - 65	PAGG. 48 - 65	PAGG. 48 - 65
RIDUTTORI GEARBOXES	PAG. 34		PAG. 34	PAG. 34		PAG. 34	PAG. 34	PAG. 34	
FLANGE MOLTIPLICATORI OVERGEARS FLANGES				PAG. 35				PAG. 35	
ACCESSORI CONTROLLO OLIO OIL CONTROL ACCESSORIES	PAG. 16								

50
BARHIGH PRESSURE
DIAPHRAGM PUMPS**BERTOLINI**
pumps

PBO SERIES



PBO 1100.1 - 1250.1

POMPA PUMP	PBO 1100.1 VD	PBO 1100.1 MF	PBO 1100.1 VP	PBO 1100.1 VP1	PBO 1250.1 VD	PBO 1250.1 MF	PBO 1250.1 VP
ACCESSORI ACCESSORIES	37506597B 1316,52 €	37506697B 1350,95 €	37506797B 1368,09 €	37507097B 1368,09 €	37511197B 1395,23 €	37511297B 1429,65 €	37511397B 1446,80 €
PULEGGIA PULLEY	3A ø 310 318463973 271,35 €		3A ø 310 318672973 271,35 €		3A ø 310 318463973 271,35 €		3A ø 310 318672973 271,35 €
CUFFIA DI PROTEZIONE ANTERIORE FRONT SAFETY CONE	311466322 12,29 €						
CUFFIA DI PROTEZIONE POSTERIORE REAR SAFETY CONE	311482322 17,01 €		311482322 17,01 €		311482322 17,01 €		311482322 17,01 €
VALVOLA DI SICUREZZA SAFETY VALVE	VEDI PAG. 36 - SEE PAG. 36						
KIT SERBATOIO OLIO A DISTANZA REMOTE MOUNTED OIL TANK	239823973 66,15 €						
RIDUTTORI PER P.D.F. 1"3/8 GEARBOXES FOR P.T.O. 1"3/8			R152 321100973 556,20 €				R152 321100973 556,20 €
GIUNTO ELASTICO 1" 3/8 GREZZO LATO MOTORE FLEXIBLE COUPLING 1" 3/8 COARSE ENGINE SIDE			31831997A CONSULTAR				31831997A CONSULTAR
GIUNTO ELASTICO 1" 3/8 LAVORATO FEMMINA 1" LATO MOTORE FLEXIBLE COUPLING 1" 3/8 MACHINED 1" FEMALE ENGINE SIDE			319117973 CONSULTAR				319117973 CONSULTAR
DISTRIBUTORI CONTROL UNITS	PAGG. 48 - 65	PAGG. 48 - 65	PAGG. 48 - 65		PAGG. 48 - 65	PAGG. 48 - 65	PAGG. 48 - 65
FLANGE MOLTIPLICATORI OVERGEARS FLANGES		PAG. 35				PAG. 35	
ACCESSORI CONTROLLO OLIO OIL CONTROL ACCESSORIES	PAG. 16	PAG. 16	PAG. 16		PAG. 16	PAG. 16	PAG. 16

50
BARHIGH PRESSURE
DIAPHRAGM PUMPSBERTOLINI
pumps

PBO SERIES



PBO 1440.1 - 1540.1 - 1840.1

POMPA PUMP	PBO 1440.1 VD	PBO 1440.1 MF	PBO 1440.1 VP	PBO 1540.1 VD	PBO 1540.1 MF	PBO 1540.1 VP	PBO 1840.1 VD	PBO 1840.1 MF	PBO 1840.1 VP
ACCESSORI ACCESSORIES	41701597B 1725,84 €	41701697B 1778,76 €	41701797B 1811,70 €	41711297B 1830,33 €	41711397B 1881,77 €	41711497B 1900,40 €	41715897B 2037,83 €	41715997B 2090,75 €	41716097B 2109,38 €
PULEGGIA PULLEY	3A ø 310 318463973 271,35 €		3A ø 310 318672973 172,80 €	3A ø 310 318463973 271,35 €		3A ø 310 318672973 172,80 €	3A ø 310 318463973 171,35 €		3A ø 310 318672973 172,80 €
CUFFIA DI PROTEZIONE ANTERIORE FRONT SAFETY CONE	311466322 12,29 €								
CUFFIA DI PROTEZIONE POSTERIORE REAR SAFETY CONE	311482322 17,01 €		311482322 17,01 €	311482322 17,01 €		311482322 17,01 €	311482322 17,01 €		311482322 17,01 €
VALVOLA DI SICUREZZA SAFETY VALVE	VEDI PAG. 36 - SEE PAG. 36								
KIT SERBATOIO OLIO A Distanza REMOTE MOUNTED OIL TANK	23982497A 133,65 €								
RIDUTTORI PER P.D.F. 1"3/8 GEARBOXES FOR P.T.O. 1"3/8			R152 321100973 556,20 €			R152 321100973 556,20 €			R152 321100973 556,20 €
GIUNTO ELASTICO 1" 3/8 GREZZO LATO MOTORE FLEXIBLE COUPLING 1" 3/8 COARSE ENGINE SIDE			31831997A 369,90 €			31831997A 369,90 €			31831997A 369,90 €
GIUNTO ELASTICO 1" 3/8 LAVORATO FEMMINA 1" LATO MOTORE FLEXIBLE COUPLING 1" 3/8 MACHINED 1" FEMALE ENGINE			319117973 383,40 €			319117973 383,40 €			319117973 383,40 €
DISTRIBUTORI CONTROL UNITS	PAGG. 48 - 65	PAGG. 48 - 65	PAGG. 48 - 65	PAGG. 48 - 65	PAGG. 48 - 65	PAGG. 48 - 65	PAGG. 48 - 65	PAGG. 48 - 65	PAGG. 48 - 65
FLANGE MOLTIPLICATORI OVERGEARS FLANGES		PAG. 35			PAG. 35			PAG. 35	
ACCESSORI CONTROLLO OLIO OIL CONTROL ACCESSORIES	PAG. 16	PAG. 16	PAG. 16	PAG. 16	PAG. 16	PAG. 16	PAG. 16	PAG. 16	PAG. 16

50
BARHIGH PRESSURE
DIAPHRAGM PUMPSBERTOLINI
pumps

IDB SERIES



IDB 1100 - 1250



IDB 1104.1

POMPA PUMP	IDB 1100 VD SV	IDB 1100 VM SV	IDB 1250 VD SV	IDB 1250 VM SV	IDB 1104.1 VD SV	IDB 1104.1 MF SV
ACCESSORI ACCESSORIES	485000973 1926,45 €(*)	485010973 1996,65 €(*)	486050973 2012,15 €(*)	486051973 2091,15 €(*)	367005973 1919,70 €	367006973 1867,05 €
PULEGGIA PULLEY	3A Ø 310 318463973 271,35 €		3A Ø 310 318463973 271,35 €		3A Ø 310 318463973 271,35 €	
VALVOLA DI SICUREZZA SAFETY VALVE	VEDI PAG. 36 - SEE PAG. 36					
KIT VALVOLA SICUREZZA 50 BAR SAFETY VALVE KIT 50 BAR	499804973 73,04 €					
CUFFIA DI PROTEZIONE ANTERIORE FRONT SAFETY CONE	311482322 17,01 €					
CUFFIA DI PROTEZIONE POSTERIORE REAR SAFETY CONE	311482322 17,01 €					
KIT ACCUMULATORE OT CPL (OPT.) PULSATION DAMPER KIT BRASS (OPT.)	489817973 (**) 222,75 €					
DISTRIBUTORI CONTROL UNITS	PAGG. 48 - 65	PAGG. 48 - 65	PAGG. 48 - 65	PAGG. 48 - 65	PAGG. 48 - 65	PAGG. 48 - 65
FLANGE MOLTIPLICATORI OVERGEARS FLANGES		PAG. 35		PAG. 35		
ACCESSORI CONTROLLO OLIO OIL CONTROL ACCESSORIES	PAG. 16	PAG. 16	PAG. 16	PAG. 16	PAG. 16	PAG. 16
RIDUTTORI PER PDF 1" 3/8 GEARBOXES FOR P.T.O. 1" 3/8		R152 318927973 754,65 €		R152 318927973 754,65 €		
GIUNTO ELASTICO 1" 3/8 GREZZO LATO MOTORE FLEXIBLE COUPLING 1" 3/8 COARSE ENGINE SIDE		31831997A 369,90 €		31831997A 369,90 €		
GIUNTO ELASTICO 1" 3/8 LAVORATO FEMMINA 1" LATO MOTORE FLEXIBLE COUPLING 1" 3/8 MACHINED 1" FEMALE ENGINE SIDE		319117973 383,40 €		319117973 383,40 €		

(*) PREZZO POMPA CON ACCUMULATORE STD 489802973 INCLUSO - PUMP PRICE WITH STD PULSATION DAMPER 489802973 INCLUDED

(**) ACCUMULATORE PRESSIONE IN OTTONE 489817973 OPTIONAL - OPTIONAL BRASS PULSATION DAMPER 489817973

50
BAR

**HIGH PRESSURE
DIAPHRAGM PUMPS**

BERTOLINI
pumps

IDB SERIES



IDB 1400 - 1600 - 1800 - 2000



IDB 2600

POMPA PUMP	IDB 1400 VD SV	IDB 1400 VM SV	IDB 1600 VD SV	IDB 1800 VD SV	IDB 2000 VD SV	IDB 2600 VD SV
ACCESSORI ACCESSORIES	49600097A 2737,80 € SENZA ACCUMULATORE WITHOUT PRESSURE DAMPER	49600197A 2782,35 € SENZA ACCUMULATORE WITHOUT PRESSURE DAMPER	49601097A 3214,35 € (*)	49602097A 3258,90 € (*)	49603097A 3360,15 € (**)	516000973 5767,20 € (**)
PULEGGIA PULLEY	3A Ø 310 318463973 271,35 €		3A Ø 310 318463973 271,35 €	3A Ø 310 318463973 271,35 €	3A Ø 310 318463973 271,35 €	3A Ø 310 318463973 271,35 €
VALVOLA DI SICUREZZA SAFETY VALVE	VEDI PAG. 36 - SEE PAG. 36					
KIT VALVOLA SICUREZZA 50 BAR SAFETY VALVE KIT 50 BAR	499804973 73,04 €					
CUFFIA DI PROTEZIONE ANTERIORE FRONT SAFETY CONE	311482322 17,01 €					
CUFFIA DI PROTEZIONE POSTERIORE REAR SAFETY CONE	311468322 12,29 €		311468322 12,29 €	311468322 12,29 €	311468322 12,29 €	311468322 12,29 €
KIT ACCUMULATORE (STD) PULSATION DAMPER KIT (STD)	489802973 151,20 €	489802973 151,20 €	INCLUSO INCLUDED	INCLUSO INCLUDED	INCLUSO INCLUDED	INCLUSO INCLUDED
KIT ACCUMULATORE OTT.CPL (OPT.) PULSATION DAMPER KIT BRASS (OPT.)	489817973 222,75 €					
DISTRIBUTORI CONTROL UNITS	PAGG. 48 - 65	PAGG. 48 - 65	PAGG. 48 - 65	PAGG. 48 - 65	PAGG. 48 - 65	PAGG. 48 - 65
FLANGE MOLTIPLICATORI OVERGEARS FLANGES		PAG. 35				
ACCESSORI CONTROLLO OLIO OIL CONTROL ACCESSORIES	PAG. 16	PAG. 16	PAG. 16	PAG. 16	PAG. 16	PAG. 16
RIDUTTORI PER PDF 1" 3/8 GEARBOXES FOR P.T.O. 1" 3/8		R152 318927973 754,65 €				
GIUNTO ELASTICO 1" 3/8 GREZZO LATO MOTORE FLEXIBLE COUPLING 1" 3/8 COARSE EN- GINE SIDE		31831997A 369,90 €				
GIUNTO ELASTICO 1" 3/8 LAVORATO FEMMINA 1" LATO MOTORE FLEXIBLE COUPLING 1" 3/8 MACHINED 1" FEMALE ENGINE SIDE		319117973 383,40 €				

(*) ACCUMULATORE STD 489802973 INCLUSO - PULSATION DAMPER 489802973 INCLUDED

(**) ACCUMULATORE PRESSIONE IN OTTONE 489817973 INCLUSO - BRASS PULSATION DAMPER 489817973 INCLUDED

70
BARHIGH PRESSURE
PISTON PUMPSBERTOLINI
pumps

PISTON PUMPS



C 40.1



C 53.3

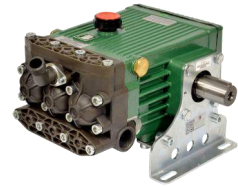

C 75.1

	POMPA PUMP	C40.1 P SV	C53.3 P SV	C53.3 PP SV	C75.1 P SV	C75.1 PP SV
ACCESSORI ACCESSORIES		389906973 841,05 €	53600097A 1000,35 €	53600497A 1125,10 €	53700097A 1180,64 €	53700197A 1259,55 €
PULEGGIA PULLEY		2A ø 130 389873973 62,10 €	3A ø 310 318722973 136,35 €			
KIT ALBERO SCANALATO 1"3/8 1"3/8 SPLINE SHAFT		318853973 75,60 €				
VALVOLA DI SICUREZZA SAFETY VALVE	VEDI PAG. 36 - SEE PAG. 36					
CUFFIA DI PROTEZIONE - SAFETY CONE			311468322 12,29 €		311468322 12,29 €	
DISTRIBUTORI - CONTROL UNITS		PAG. 48 - 65	PAG. 48 - 65	PAG. 48 - 65	PAG. 48 - 65	PAG. 48 - 65
RIDUTTORI - GEARBOXES		PAG. 34	PAG. .33	PAG. 34	PAG. 34	



CKA 73 - 110 - 120

	POMPA PUMP	CKA 73-P SV	CKA 73-PP SV	CKA 110-P SV	CKA 110-PP SV	CKA 120-P SV	CKA 120-PP SV
ACCESSORI ACCESSORIES		735300973 1636,20 €	735301973 1668,60 €	735302973 1568,46 €	735303973 1759,05 €	735304973 1703,46 €	735305973 1737,82 €
PULEGGIA PULLEY		3A ø 310 318463973 271,35 € 4A ø 310 318363973 369,90 €	3A ø 310 318841973 143,10 €	3A ø 310 318463973 271,35 € 4A ø 310 318363973 369,90 €	3A ø 310 318841973 143,10 €	3A ø 310 318463973 271,35 € 4A ø 310 318363973 369,90 €	3A ø 310 318841973 143,10 €
KIT RACCORDO MANDATA 3/4 OUTLET PIPE FITTING KIT 3/4		731004973 17,55 €					
KIT MANOMETRO PRESSURE GAUGE KIT		731026973 55,35 €					
VALVOLA DI SICUREZZA SAFETY VALVE	VEDI PAG. 36 - SEE PAGE. 36						
CUFFIA DI PROTEZIONE SAFETY CONE		311482322 17,01 €		311482322 17,01 €		311482322 17,01 €	
DISTRIBUTORI CONTROL UNITS	VEDI PAG. 48 - 65 — SEE PAGES 48 - 65						

70
BARHIGH PRESSURE
PISTON PUMPS**BERTOLINI**
pumps

PISTON PUMPS



CX 130 - 150 - 170

	POMPA PUMP	CX 130 P SV	CX 150 P SV	CX 170 P SV
ACCESSORI ACCESSORIES		741009973 €. 4.950,45	741008973 €. 4.950,45	741003973 €. 4.950,45
PULEGGIA PULLEY		3A ø 310 318841973 €. 143,10		
KIT RACCORDO MANDATA 3/4 OUTLET PIPE FITTING KIT 3/4		731004973 €. 17,55		
KIT MANOMETRO PRESSURE GAUGE KIT		731026973 €. 55,35		
VALVOLA DI SICUREZZA SAFETY VALVE		VEDI PAG. 36 - SEE PAGE. 36		
CUFFIA DI PROTEZIONE SAFETY CONE		311482322 €. 17,01		
DISTRIBUTORI CONTROL UNITS		VEDI PAG. 48 - 65 — SEE PAGES 48 - 65		

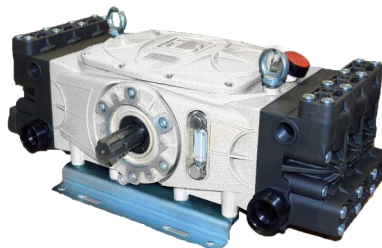
CKA 146 - 170 - 180
220 - 230- 240 - 270

	CKA 146 P SV	CKA 146 PP SV	CKA 170 P SV	CKA 170 PP SV		CKA 180 PP SV
POMPA PUMP	767400973 €. 3.0013,20	767401973 €. 3.229,20	767402973 €. 3.253,50	767403973 €. 3.323,70		767407973 €. 3.676,05
ACCESSORI ACCESSORIES	CKA 220 P SV 767404973 €. 3.520,80	CKA 220 PP SV 767405973 €. 3.766,50		CKA 230 PP SV 767408973 €. 3.766,50	CKA 240 P SV 767406973 €. 3.802,95	CKA 270 PP SV 767409973 €. 3.802,95
PULEGGIA PULLEY	3A ø 310 318463973 €. 271,35 4A ø 310 318363973 €. 369,90	3A ø 310 318841973 €. 143,10	3A ø 310 318463973 €. 271,35 4A ø 310 318363973 €. 369,90	3A ø 310 318841973 €. 143,10	3A ø 310 318463973 €. 271,35 4A ø 310 318363973 €. 369,90	3A ø 310 318841973 €. 143,10
KIT RACCORDO MANDATA 3/4 OUTLET PIPE FITTING KIT 3/4	731004973 €. 17,55					
KIT MANOMETRO PRESSURE GAUGE KIT	731026973 €. 55,35					
VALVOLA DI SICUREZZA SAFETY VALVE	VEDI PAG. 36 - SEE PAGE. 36					
CUFFIA DI PROTEZIONE SAFETY CONE	311482322 €. 17,01		311482322 €. 17,01		311482322 €. 17,01	
DISTRIBUTORI CONTROL UNITS	VEDI PAG. 48 - 65 — SEE PAGES 48 - 65					

20
BAR

**LOW PRESSURE
DIAPHRAGM PUMPS**

BERTOLINI
pumps



STRIP 9/10
STRIP 15/15



STRIP 15/5

GRUPPI ELETTROPOMPE 12 VOLT - MOTOR PUMP UNITS 12 V MOTOR	MODELLO MOTORE MOTOR MODEL	ACCOPIAMENTO COUPLING	CODICE PART NR.	PREZZO PRICE
STRIP 9/10 (+ PBP 25)	12 VDC 0.14 Kw	IEC 1 Albero/shaft 14 mm	117006973	€ 1.032,75
STRIP 15/5 (+ NPR)	12 VDC 0.14 Kw		117007973	€ 946,35
STRIP 15/15 (+ PBP 25)	12 VDC 0.39 Kw		117013973	€ 1.032,75
STRIP 9/10 SV	12 VDC 0.14 Kw		117021973	€ 957,15
STRIP 15/5 SV	12 VDC 0.14 Kw		117022973	€ 899,10
STRIP 15/15 SV	12 VDC 0.39 Kw		117023973	€ 957,15



NEW DURAMAX
MEMBRANE



POLY 2020.1 HP

GRUPPI ELETTROPOMPE 12 VOLT - MOTOR PUMP UNITS 12 VOLTS MOTOR	MODELLO MOTORE MOTOR MODEL	ACCOPIAMENTO COUPLING	CODICE PART NR.	PREZZO PRICE
POLY 2020.1 HP 12VDC (MEC70) + PBP	12 VDC 0.14 Kw	IEC 1 Albero/shaft 14 mm	94856497ADS	€ 1.155,60



NEW DURAMAX
MEMBRANE



POLY 2030.1

GRUPPI ELETTROPOMPE 12 VOLT - MOTOR PUMP UNITS 12 VOLTS MOTOR	MODELLO MOTORE MOTOR MODEL	ACCOPIAMENTO COUPLING	CODICE PART NR.	PREZZO PRICE
POLY 2030.1 12VDC (MEC70) + KARIN	12 VDC 0.39 Kw	IEC 71 Albero/shaft 14 mm	94746497ADS	€ 1.200,15

POMPA — PUMP		MOTORE — MOTOR		VALVOLA PRESS. REG.	Cod. Gruppo Part nr.	PREZZO PRICE
SERIE	MOD.	ELECTRIC MOTOR	PETROL ENGINE	MOD.		
 STRIP	D4	/	RADO RV80V (4T-2Kw)		117011973	€ 814,05
	DE 80	Mnf.-0.8KW (C)	/			117008973
			/	117015973		€ 837,00
	DE 71	Mnf.-0.8Kw (B)	/	117016973	€ 720,90	
 POLY 2020.1 HP DURAMAX	RT4.1	/	RADO RV80V (4T-2Kw)		94856297ADS	€ 1.035,45
	RTE.1	Mnf.-1 Kw (B)	/		94856097ADS	€ 934,20
	RTE.1	Trf.-1 Kw (B)	/		94856197ADS	€ 918,00
	RT4.1	/	RADO RV80V (4T-2Kw)		94866297ADS	€ 1.078,65
	RTE.1	Mnf.-1.5 Kw (B)	/		94866097ADS	€ 1.001,70
POLY 2025.1 HP DURAMAX	RTE.1	Trf.-1.5 Kw (B)	/	94866197ADS	€ 926,10	
 POLY 2030.1 DURAMAX	RT4.1	/	RADO RV80V (4T-2Kw)		94746297ADS	€ 1.120,50
	RTE.1	Mnf.-1.5Kw (B)	/		94746097ADS	€ 1.038,15
		Trf.-1.5Kw (B)	/		94746197ADS	€ 962,55
 POLY 2073 DURAMAX	VA	/	YAMAHA MX200 (4T-4,2Kw)		638006973DS	€ 2.104,65
		/	Kohler SH 265 (4T-4.5Kw)		63800297ADS	€ 1.983,15
	VP	Trf.- 3 Kw (C)	/		63800197ADS	€ 1.765,80

(B) = Motore speciale Bertolini—Bertolini special version motor
(C) = Motore commerciale—Commercial motor

POMPA — PUMP		MOTORE — MOTOR		VALVOLA PRESS. REG.	Cod. Gruppo Part nr.	PREZZO PRICE
SERIE	MOD.	ELECTRIC MOTOR	PETROL ENGINE	MOD.		
 PA 330.1	VF	/	YAMAHA MX200 (4T-4,2Kw)		038023973	€ 1.817,10
		/	AXO AMG 210 (4T-4Kw)		03802097B	€ 1.460,70
		/	Kohler SH 265 (4T-4.5Kw)		03800997A	€ 1.764,45
		Mnf.-1.8Kw (B)	/		038504973	€ 1.408,05
		Trf.-2.2 Kw (B)	/		038505973	€ 1.418,85
 PA 430.1	VF	/	YAMAHA MX200 (4T-4,2Kw)		038024973	€ 1.574,10
		/	AXO AMG 210 (4T-4Kw)		03802197B	€ 1.500,00
		/	Kohler SH 265 (4T-4.5Kw)		03802297A	€ 1.775,25
		Trf.-2.2 Kw (B)	/		038508973	€ 1.516,05
 PA 530	VF	/	YAMAHA MX 300 (4T-7 KW)		238015973	€ 3.740,85
		Trf.-4 Kw (C)	/		23802197A	€ 2.103,30
 PA 730.1	VF	/	YAMAHA MX 300 (4T-7 KW)		238016973	€ 3.854,25
		Trf.-5.5 Kw (C)	/		23802697A	€ 2.488,05
 C 40.1	Std.	/	AXO AMG 210 (4T-4Kw)		38860197B	€ 2.076,30
		Trf.-4 Kw (C)	/		38860097A	€ 1.852,20
		/	YAMAHA MX200 (4T-4,2Kw)		388604973	€ 1.500,00
 C53.3	PP	Trf.-5.5 Kw (C)			53810097A	€ 2.236,95
			YAMAHA MX 300 (4T-7 KW)		538001973	€ 2.278,80

(B) = Motore speciale Bertolini—Bertolini special version motor
(C) = Motore commerciale—Commercial motor

MODELLO - MODEL

POMPA PUMP	MOTORE IDRAULICO HYDRAULIC MOTOR	CODICE PART NR.	PREZZO PRICE
POLY 2020 HP VF	50 CC	94854197ADS	€ 1.146,15
POLY 2073 VI 25mm	50 CC	638005973DS	€ 1.229,85
POLY 2085 VI 25mm	50 CC	638007973DS	€ 1.215,00
POLY 2120 VC 25mm	80 CC	628006973DS	€ 1.512,00
POLY 2150 VC 25mm	80 CC	628007973DS	€ 1.539,00
POLY 2180 VC 25mm	80 CC	289279973DS	€ 2.003,40
POLY 2210 VC 25mm	100 CC	557013973DS	€ 2.581,20
POLY 2240 VC 25mm	100 CC	557014973DS	€ 2.654,10
POLY 2260 VC 25mm	100 CC	146070973DS	€ 2.902,50
POLY 2300 VC 25mm	100 CC	146033973DS	€ 2.964,60
PA 330.1 VI 25mm	50 CC	038102973	€ 930,15
PA 430.1 VI 25mm	50 CC	038103973	€ 918,81
PA 440 VI 25mm	50 CC	038104973	€ 1.016,01
PA 530 VI 25mm	50 CC	238017973	CONSULTAR
PA 730.1 VI 25mm	80 CC	238018973	€ 1.322,33
PA/S 830 VI 25mm	80 CC	238019973	€ 1.484,06
PA/S 930 VI 25mm	100 CC	238020973	€ 1.615,68
IDB 1100 VD	125 CC	487000973	€ 3.365,55
IDB 1104 VD	80 CC	367050973	€ 2.835,00
CK 73.1 P	100 CC	739231973	€ 2.569,05



POLY 2020





POLY 2073 VI



POLY 2300



IDB

	MODELLO MODEL	CODICE PART NR.	PREZZO PRICE	MODELLI DI POMPE PUMPS MODELS	NOTE NOTES
 <p>MAX 40 L/MIN 15/40 BAR</p> <p>KARIN</p>	KARIN 2 VIE - 2 WAYS	244011973	€. 112,05	POLY 2030	15 BAR
	KARIN 2 VIE - 2 WAYS	244001973	€. 112,05	PA 330.1 - PA 430.1 - PA 530.1 - C 40.1	40 BAR
	KARIN 3 VIE - 3 WAYS	244028973	€. 117,45		
	KARIN 4 VIE - 4 WAYS	244035973	€. 126,90		
STING 3 VIE - 3 WAYS	244010973	€. 133,65	POLY 2073 - 2085		
 <p>MAX 90 L/MIN 15-50 BAR</p> <p>STING</p>	STING 4 VIE - 4 WAYS	244004973	€. 144,45	PA 530 - PA 730.1 - PA/S 830 - 930	40 BAR
	STING 2 VIE - 2 WAYS	244000973	€. 126,90		
	STING 3 VIE - 3 WAYS	244002973	€. 133,65	Esecuzione con manometro in verticale Vertical pressure gauge	50 BAR
	STING 3 VIE - 3 WAYS	244006973	€. 133,65		
	STING 4 VIE - 4 WAYS	244003973	€. 144,45	PA 530 - PA 730.1 - PA/S 830 - 930	50 BAR
	STING 2 VIE - 2 WAYS	244005973	€. 126,90	C 53.3 - C 75.1 P	
	STING 3 VIE - 3 WAYS	244008973	€. 133,65		
	 <p>90-110 L/MIN 15/40 BAR</p> <p>ANTI DRIP</p> <p>STING PLUS</p>	STING PLUS 3 VIE - 3 WAYS	24570197A	€. 152,55	POLY 2073
STING PLUS 4 VIE - 4 WAYS		24570297A	€. 172,80	POLY 2073	40 BAR
STING PLUS 2 VIE - 2 WAYS		24570397A	€. 136,35	PA 530 - PA 730.1 - PA/S 830 - 930	
STING PLUS 3 VIE - 3 WAYS		24570497A	€. 152,55	PA 530 - PA 730.1 - PA/S 830 - 930	
STING PLUS 4 VIE - 4 WAYS		24570597A	€. 172,80	PA 530 - PA 730.1 - PA/S 830 - 930	

(1)
Vedi
Nota
Pag. 31



See
Note
Pag. 31



50
BAR

MULTI DIRECTIONAL VALVES

BERTOLINI
pumps

MOBY - C.D.MOBY - VS

	MODELLO MODEL	CODICE PART NR.	PREZZO PRICE	MODELLI DI POMPE PUMPS MODELS	NOTE NOTES
MOBY 	VRP MOBY STD	246010973	€. 267,30	PPS IDB CK 73.1 P - CK146 P - CK220 P CK110.1 - CK120.1	70 BAR SENZA MANOMETRO WITHOUT PRESSURE GAUGE
	VRP MOBY STD	246000973	€. 299,70	PPS IDB CK73.1 P - CK146 P - CK220 P CK110.1 - CK120.1	70 BAR CON MANOMETRO WITH PRESSURE GAUGE
C.D. MOBY 	Comando a distanza MOBY REMOTE CONTROL MOBY	246020973	€. 363,15	PPS PBO.1 IDB C75.1 P - CK110.1 P - CK120.1 P CK146 P - CK 220 P -	70 BAR
VS 	VS 700	739834973	CONSULTAR	C75.1 P - CK146 P - CK220 P CK110.1 - CK120.1 P	50 BAR
	VS 1500	739832973	CONSULTAR	C75.1 P - CK146 P - CK220 P CK110.1 - CK120.1 P	100 BAR

	DESCRIZIONE DESCRIPTION	VALVOLA REGOLAZIONE PRESSIONE PRESSURE REGULATOR	CODICE PART NR.	PREZZO PRICE
	KIT ACCESSORI ORIENTABILI - 1/2" ADJUSTABLE REMOTE MOUNTING KIT 1/2"	KARIN - STING - STING PLUS	318911973	€. 33,75
	KIT ACCESSORI ORIENTABILI - 3/4" ADJUSTABLE REMOTE MOUNTING KIT 3/4"	STING - STING PLUS	318912973	€. 37,80
	KIT ACCESSORI 3/4" - REMOTE MOUNTING KIT 3/4"	VRP MOBY	246021973	€. 99,90
	KIT ACCESSORI 3/4" D. 20 REMOTE MOUNTING KIT 3/4" D. 20	STING - STING PLUS	318928973	€. 49,95
	DESCRIZIONE DESCRIPTION	MODELLO POMPA PUMP MODEL	CODICE - PART NR.	PREZZO - PRICE
	KIT DI MANDATA — OUTLET KIT G . 1/2	PA330.1 - PA430.1 - PA530	318916973	€. 17,55
	KIT MANDATA — OUTLET KIT G . 3/4	PA 730.1 - PA 830 - PA/S 930 PBO	318917973	€. 18,90

NOTE :

- (1) - per collegare i regolatori alle pompe C53.3 P ordinare kit attacco valvola cod. 318743973
for mounting the regulator on C53.3 P pumps, order kit part n° 318743973
- (2) - per collegare i regolatori alle pompe IDB a 3 membrane, ordinare kit cod. 249801973
for mounting the regulator on IDB with 3 diaphragms, order kit part n° 249801973
- per collegare i regolatori alle pompe IDB a 5 membrane, ordinare kit cod. 249802973
for mounting the regulator on IDB with 5 diaphragms, order kit part n° 249802973
- per collegare i regolatori alle pompe serie C e CK, ordinare cod. 835060352
for mounting the regulator on C and CK pumps, order part n° 835060352

prezzo € 17,55

price

prezzo € 83,70

price

prezzo € 37,80

price

prezzo CONSULTAR

price





	DESCRIZIONE DESCRIPTION	CODICE PART NUMBER	PREZZO PRICE
	RACCORDO ORIENTABILE ADJUSTABLE FITTING	321207973	€. 18,90

50
BAR

MULTI DIRECTIONAL VALVES

BERTOLINI
pumps

MULTIDUPLO-VIG

MODELLO MODEL	CODICE PART NR.	PREZZO PRICE	MODELLI DI POMPE PUMPS MODELS
 MULTIDUPLO 2RSM 2 VIE - 2 WAYS	242070973	€. 259,20	PA 730.1 - PA/S 830-930 PBO.1 IDB CK 73.1 - CK146 - CK110.1 - CK120.1
MULTIDUPLO 3RSM 3 VIE - 3 WAYS	242071973	€. 271,35	
MULTIDUPLO 4RSM 4 VIE - 4 WAYS	242075973	€. 288,90	
 MULTIDUPLO 2RSM + VGE MULTIDUPLO WITH MOTOR. ON/OFF VALVE + 2 RSM SECTION VALVES	242073973	€. 535,95	PA 730.1 - PA/S 830 - 930 PBO.1 IDB CK73.1 - CK110.1 - CK146 P - CK120.1
MULTIDUPLO 3RSM + VGE MULTIDUPLO WITH MOTOR. ON/OFF VALVE N° 3 RSM SECTION VALVES	242074973	€. 552,15	
MULTIDUPLO 4RSM + VGE MULTIDUPLO WITH MOTOR. ON/OFF VALVE N° 4 RSM SECTION VALVES	242093973	€. 569,70	
 SET VALVOLE MOTORIZZATE 2 RSE MOTOR. SECTION VALVES SET 2 RSE	242082973	€. 847,80	PA730.1 - PA/S 830-930 PBO.1 IDB CK73.1 - CK110.1 - CK146 P - CK120.1
SET VALVOLE MOTORIZZATE 2 RDE MOTOR. SECTION VALVES SET 2 RDE	242083973	€. 954,45	
 VIG	241094973	€. 295,65	PA 530 - 730.1 - 830 PBO IDB C53.3 P - C75.1 P CK146 - CK220 - CK110.1 - CK120.1

**KIT PORTAGOMMA E GALLETTO PER MULTIDUPLO - VIG - LANCE
OUTLET HOSETAILS KIT**

	DESCRIZIONE - DESCRIPTION	CODICE PART NR.	PREZZO PRICE
	KIT PORTAGOMMA MANDATA Ø 10 mm. - OUTLET HOSETAIL Ø 10 mm.	249010973	€. 9,45
	KIT PORTAGOMMA MANDATA Ø 12 mm. - OUTLET HOSETAIL Ø 12 mm.	249012973	€. 9,45

**RIDUTTORI PER APPLICAZIONE A MACCHINE AGRICOLE (MOTOZAPPE)
GEARBOXES FOR AGRICULTURAL MACHINERY**

MODELLO MODEL	RAPPORTO RATIO	MODELLO POMPA PUMP MODEL	CODICE PART NR.	PREZZO PRICE
RD146	1:4,6	POLY 2020-2025 PA (VF-VC)	318809973	€. 375,30
RD116	1:1,6		318840973	€. 419,85

**RIDUTTORI PER MOTORI ELETTRICI CON FLANGIA E CONTROFLANGIA
GEARBOXES FOR ELECTRIC MOTORS WITH FLANGE AND COUNTERFLANGE**

MODELLO MODEL	RAPPORTO RATIO	MOTORE MOTOR	MODELLO POMPA PUMP MODEL	CODICE PART NR.	PREZZO PRICE
RE 155	1:4,5	BERTOLINI (2P H90)	PA 330.1 VF	318719973	€. 105,30
RE 127	1:2,7	B3-B14 H100-112 (4 poli/poles)	PA 530-730 (VF-VC)	321053973	€. 380,70
			POLY 2073-2085 VP	321056973	€. 388,80
			C 53.3 - C 75.1	32105697A	€. 394,20
RE 127	1:2,7	B3-B14 H132 (4 poli/poles)	PPS 100 VP	321061973	€. 653,40
			PPS 1211 - 1212 VP	321069973	€. 697,95
			PPS 1613 - 1615 VP	321070973	€. 683,10
			PBO.1 VP	321065973	€. 463,05

**RIDUTTORI PER MOTORI A SCOPPIO CON ALBERO CILINDRICO 3/4"
GEARBOXES FOR PETROL ENGINE WITH SOLID SHAFT 3/4"**

MODELLO MODEL	RAPPORTO RATIO	MOTORE MOTOR	MODELLO POMPA PUMP MODEL	CODICE PART NR.	PREZZO PRICE
RTA 155	1:5,5	SAE 3/4 L=62 SAE 18 mm L=62 SAE 20 mm L=62	PA 330.1-430.1 VF	321000973	€. 251,10
			PA 330.1-430.1 VF	321004973	€. 209,25
			PA 330.1-430.1 VF	321002973	€. 295,65
RTA 155	1:5,5	SAE 3/4 L=62	POLY 2073-2085 VA	321003973	€. 251,10
			POLY 2120-2150 VA	321005973	€. 324,00
RTA 126	1:2,6	SAE 3/4 L=62	C 40.1	321009973	€. 255,15

**RIDUTTORI PER MOTORI A SCOPPIO CON ALBERO CILINDRICO 1"
GEARBOXES FOR PETROL ENGINE WITH SOLID SHAFT 1"**

MODELLO MODEL	RAPPORTO RATIO	MOTORE MOTOR	MODELLO POMPA PUMP MODEL	CODICE PART NR.	PREZZO PRICE
RTA 126	1:2,6	SAE 1" L=93	C 40.1	321011973	€. 309,15
RTA 155	1:5,5	SAE 1" L=93	PA 330.1 - 430.1 - 530 VF	321016973	CONSULTAR
RTA 160	1:6,0	SAE 1" L=93	PA - PA/S VF-VC	321052973	€. 314,55
			PPS 1211 - 1212 VP	321068973	€. 369,90
			PBO 1110.1-1250.1 VP	321054973	€. 384,75
			POLY 2073 - 2085 VP	321055973	€. 318,60
			C 53.3 - C 75.1	32105597A	€. 336,15
			PPS 100 VP	321062973	€. 330,75
RTA 160	1:6,0	SAE 1" L=75	POLY 2260-2300 VP	321067973	€. 341,55
			PA - PA/S VF-VC	321063973	€. 319,95
			POLY 2073 - 2085 VP	321064973	€. 326,70
			C 53.3 - C 75.1	32106497A	€. 342,90

**RIDUTTORI PER MOTORI CON ALBERO CONICO Ø 23
GEARBOXES FOR MOTORS WITH TAPERED SHAFT Ø 23**

MODELLO MODEL	RAPPORTO RATIO	MOTORE MOTOR	MODELLO POMPA PUMP MODEL	CODICE PART NR.	PREZZO PRICE
RTA 160	1:6,0	Albero conico 23 mm Tapered shaft 23 mm	PA 330.1 - 430.1 - 530 - 730 - 830 VF-VC POLY 2073 - 2085 VP C 53.3 - C 75.1 PBO 1100.1 - 1250.1 VP	321057973 321059973 32105997A 321060973	€. 450,90 €. 459,00 €. 392,85 €. 514,35

GIUNTI PER MOTORI IDRAULICI — HYDRAULIC MOTOR COUPLINGS



ALBERO SHAFT	FLANGIA OVERGEAR	MODELLO POMPA PUMP MODEL	CODICE PART. NUMBER	PREZZO PRICE
Ø5/8" L=33.3	2 fori	MINIPOLY VF	321202973	€ 103,95
Ø16 L=33.3	C= Ø 63		321203973	€ 151,20
17x14 DIN5482 L=33.3	I=80		321204973	€ 201,15
Ø1" L=78	SAE "B" C= Ø 101 I=146	MINIPOLY VF PA 330.1-430.1-530-730.1 PA/S 830-930 VF-VC	318748973	€ 168,75
		POLY 2073-2085 VA	318749973	€ 148,50
Ø1" L=55.3	SAE "A" 2 fori C= Ø 82.6 I=106.4	MINIPOLY VF PA 330.1-430.1-530-730.1 PA/S 830-930 VF-VC	321200973	€ 136,35
		POLY 2073-2085-2105-2120-2150 VS	321208973	€ 145,80
		POLY 2073-2085 VA	321209973	€ 108,00
		POLY 2180-2210-2240-2260-2300 VD	318967973	€ 237,60
		PPS 100 VD IDB 1304 VD(*)	319121973	€ 222,75
		CK (P)	319223973	CONSULTAR
Ø25 L=55.3	SAE "A" 2 fori C= Ø 82.6 I=106.4	POLY 2073-2085-2105-2120-2150 VS	321210973	€ 157,95
		POLY 2180-2210-2240-2260-2300 VD	318895973	€ 187,65
		MINIPOLY VF PA 330.1-430.1-530-730.1 PA/S 830-930 VF-VC	321201973	€ 136,35
		PPS 100 VD IDB 1304 VD(*)	319120973	€ 201,15
		PBO VD (*)	318899973	€ 237,60
		IDB 1100-1250-1400-1600-1800 VD (*) PPS 1211-1212-1613-1615 VD (*) POLY 2400.1 VD	311761973	€ 261,90
Ø32 L=66	SAE "A" 4 fori C= Ø 82.6 I=106.4	POLY 2180-2210-2240-2260-2300 VD	318904973	€ 136,35
		PBO VD	318914973	€ 187,65
		PPS 100 VD IDB 1304 VD	318910973	€ 187,65
		IDB 1400-1600-1800 VD PPS 1211-1212-1613-1615 VD - POLY 2400.1 VD	311762973	€ 245,70

MARCA BRAND NAME	MODELLO MODEL	CODICE PART NR.	PREZZO PRICE
FLAN(28X25 Z=15)GIA PER POMPA IDRAULICA GRUPPO 2 ALBERO SCANALATO DIN 5482 (28X25 Z=15) FLANGE FOR HYDRAULIC PUMP GROUP 2 SPLINED SHAFT DIN 5482 (28X25 Z=15)	POLY 2180-2210-2250-2260-2300 (VD)	31895797A	€ 279,45

FLANGE PER MOLTIPLICATORE — OVERGEAR FLANGES



MARCA BRAND NAME	MODELLO MODEL	CODICE PART NR.	PREZZO PRICE	MODELLI DI POMPE PUMPS MODELS
COMER BIMA	D729A-D21F-D7A M30N-M47N-M60N	318727973	€ 74,25	PA - PA/S VM PPS 100 VM POLY 2073-2085 VM
COMER BIMA	D729A-D21F-D7A M30N-M47N-M60N	318726973	€ 82,35	PBO MF IDB VM PPS 1211-1212-1613-1615 VM
BIMA	CAR 3 (FORATURA INTERNA)	318767973	€ 90,45	PA - PA/S VM PPS 100 VM POLY 2073-2085 VM
BIMA	M60N	318962973	€ 141,75	POLY 2210-2250-2260-2300 VD
FIENI	V1N-VC2	319245973	€ 79,65	POLY 2073 - 2085 VM PA - PA/S VM
HYDR-APP	ML52	318943973	€ 141,75	IDB VD
HYDR-APP	ML52	319125973	€ 140,40	POLY 2120 - 2150
HYDR-APP	ML52	318944973	€ 140,40	POLY 2210 - 2250 - 2260 - 2300 VD
HYDR-APP	ML52	318958973	€ 180,90	CK 73 - 110- 120 P

VALVOLE DI SICUREZZA - SAFETY VALVES

	PORTATA FLOW	PRESSIONE - PRESSURE	CODICE - PART NR.	PREZZO - PRICE
	150 L/min max	6 BAR	243014973	€. 21,47
15 BAR		243016973	€. 21,47	
18 BAR		243018973	€. 24,44	
20 BAR		243020973	€. 24,44	
200 L/min max	40 BAR	243040973	€. 27,27	
	50 BAR	243050973	€. 27,27	



RACCORDI DI MONTAGGIO - MOUNTING FITTINGS

TIPO - TYPE	CODICE - PART NR.	PREZZO - PRICE
90° MF "T" M / F / F	822044502 835024002	Consultar Consultar



	PORTATA FLOW	PRESSIONE - PRESSURE	CODICE - PART NR.	PREZZO - PRICE
	400 L/min max	10 BAR	243110973	€. 42,93
11 BAR		243111973	€. 42,93	
12 BAR		243112973	€. 42,93	
13 BAR		243113973	€. 42,93	
14 BAR		243114973	€. 42,93	
15 BAR		243115973	€. 42,93	

	PORTATA FLOW	PRESSIONE - PRESSURE	CODICE - PART NR.	PREZZO - PRICE
	50 L/min max	15 BAR	243200973	€. 18,90
20 BAR		243201973	Consultar	
40BAR		243202973	Consultar	



FILTRO ASPIRAZIONE IN POLIPROPILENE CON CAPACITA' FILTRANTE FINO A 120 L/min - SUCTION FILTER IN POLYPROPYLENE WITH FILTER CAPACITY UP TO 120 L/min							
	MESH	ATTACCO / CONNECTION	TIPO / TYPE	S	H	CODICE / PART NR.	PREZZO / PRICE
	32	1"1/4	A	138	25	871100973	€ 40,50
					45	871101973	€ 40,50
			B	163	25	871102973	€ 58,05
					45	871103973	€ 58,05
			C	200	25	871104973	€ 63,45
					45	871105973	€ 63,45

RACCORDI PORTAGOMMA IN POLIPROPILENE VEDI PAG. 43
POLYPROPYLENE PIPE FITTINGS SEE PAGE 43

FILTRO ASPIRAZIONE IN POLIPROPILENE CON CAPACITA' FILTRANTE DA 100 A 160 L/min - SUCTION FILTER IN POLYPROPYLENE WITH FILTER CAPACITY FROM 100 TO 160 L/min							
	MESH	ATTACCO / CONNECTION	TIPO / TYPE	S	H	CODICE / PART NR.	PREZZO / PRICE
	32	1"1/2	A	196	25	871120973	€ 54,00
					45	871121973	€ 54,00
			B	221	25	871122973	€ 72,90
					45	871123973	€ 72,90
			C	259	25	871124973	€ 78,30
					45	871125973	€ 78,30

RACCORDI PORTAGOMMA IN POLIPROPILENE VEDI PAG. 43
POLYPROPYLENE PIPE FITTINGS SEE PAGE 43



**FILTRO ASPIRAZIONE IN POLIPROPILENE CON CAPACITA' FILTRANTE DA 160 A 220 L/min -
SUCTION FILTER IN POLYPROPYLENE WITH FILTER CAPACITY FROM 160 TO 220 L/min**

	MESH	ATTACCO/ CONNECTION	TIPO / TYPE	S	H	CODICE / PART NR.	PREZZO / PRICE
	32	1"1/2	A	236	25	871130973	€ 66,15
					45	871131973	€ 66,15
B			261	25	871132973	€ 97,20	
				45	871133973	€ 97,20	
C			299	25	871134973	€ 99,90	
				45	871135973	€ 99,90	

RACCORDI PORTAGOMMA IN POLIPROPILENE VEDI PAG. 43
POLYPROPYLENE PIPE FITTINGS SEE PAGE 43



**FILTRO ASPIRAZIONE IN POLIPROPILENE CON CAPACITA' FILTRANTE DA 160 A 220 L/min -
SUCTION FILTER IN POLYPROPYLENE WITH FILTER CAPACITY FROM 160 TO 220 L/min**

	MESH	ATTACCO/ CONNECTION	TIPO / TYPE	S	H	CODICE / PART NR.	PREZZO / PRICE
	32	2"	A	236	25	871140973	€ 66,15
					45	871141973	€ 66,15
B			261	25	871142973	€ 97,20	
				45	871143973	€ 97,20	
C			299	25	871144973	€ 99,90	
				45	871145973	€ 99,90	

RACCORDI PORTAGOMMA IN POLIPROPILENE VEDI PAG. 43
POLYPROPYLENE PIPE FITTINGS SEE PAGE 43





FILTRO ASPIRAZIONE IN POLIPROPILENE CON CAPACITA' FILTRANTE DA 200 A 260 L/min -
SUCTION FILTER IN POLYPROPYLENE WITH FILTER CAPACITY FROM 200 TO 260 L/min

	MESH	ATTACCO / CONNECTION	TIPO / TYPE	S	H	CODICE / PART NR.	PREZZO / PRICE
	32	2"	A	321	25	871150973	€ 70,20
					45	871151973	€ 70,20
			B	346	25	871152973	€ 99,90
					45	871153973	€ 99,90
			C	384	25	871154973	€ 102,60
					45	871155973	€ 102,60





RACCORDI PORTAGOMMA IN POLIPROPILENE VEDI PAG. 43
POLYPROPYLENE PIPE FITTINGS SEE PAGE 43

FILTRO ASPIRAZIONE IN POLIPROPILENE CON CAPACITA' FILTRANTE DA 200 A 260 L/min -
SUCTION FILTER IN POLYPROPYLENE WITH FILTER CAPACITY FROM 200 TO 260 L/min





	MESH	ATTACCO / CONNECTION	TIPO / TYPE	S	H	CODICE / PART NR.	PREZZO / PRICE
	32	2 1/2"	A	321	25	871160973	€ 68,85
			B	346	25	871162973	€ 99,90
			C	384	25	871164973	€ 99,90

RACCORDI PORTAGOMMA IN POLIPROPILENE VEDI PAG. 43
POLYPROPYLENE PIPE FITTINGS SEE PAGE 43



FILTRO ASPIRAZIONE IN POLIPROPILENE CON CAPACITA' FILTRANTE FINO A 120 L/min - SUCTION FILTER IN POLYPROPYLENE WITH FILTER CAPACITY UP TO 120 L/min							
	MESH	T	TIPO / TYPE	S	H	CODICE / PART NR.	PREZZO / PRICE
	32		A	138	33	871107973	€ 40,50
			B	163	33	871108973	€ 58,05
			C	200	33	871109973	€ 63,45





RACCORDI PORTAGOMMA IN POLIPROPILENE VEDI PAG. 43
POLYPROPYLENE PIPE FITTINGS SEE PAGE 43

FILTRO ASPIRAZIONE IN POLIPROPILENE CON CAPACITA' FILTRANTE DA 100 A 160 L/min - SUCTION FILTER IN POLYPROPYLENE WITH FILTER CAPACITY FROM 100 TO 160 L/min							
	MESH	ATTACCO / CONNECTION	TIPO / TYPE	S	H	CODICE / PART NR.	PREZZO / PRICE
	32		A	196	33	871127973	€ 54,00
			B	221	33	871128973	€ 72,90
			C	259	33	871129973	€ 78,30

RACCORDI PORTAGOMMA IN POLIPROPILENE VEDI PAG. 43
POLYPROPYLENE PIPE FITTINGS SEE PAGE 43







FILTRO ASPIRAZIONE IN POLIPROPILENE CON CAPACITA' FILTRANTE DA 160 A 220 L/min -
SUCTION FILTER IN POLYPROPYLENE WITH FILTER CAPACITY FROM 160 TO 220 L/min

	MESH	ATTACCO/ CONNECTION	TIPO / TYPE	S	H	CODICE / PART NR.	PREZZO / PRICE
	32		A	236	33	871137973	€. 66,15
			B	261	33	871138973	€. 97,20
			C	299	33	871139973	€. 99,90

RACCORDI PORTAGOMMA IN POLIPROPILENE VEDI PAG. 43
POLYPROPYLENE PIPE FITTINGS SEE PAGE 43





FILTRO ASPIRAZIONE IN POLIPROPILENE CON CAPACITA' FILTRANTE DA 160 A 220 L/min -
SUCTION FILTER IN POLYPROPYLENE WITH FILTER CAPACITY FROM 160 TO 220 L/min

	MESH	ATTACCO/ CONNECTION	TIPO / TYPE	S	H	CODICE / PART NR.	PREZZO / PRICE
	32		A	236	36,5	871137973	€. 66,15
			B	261	36,5	871148973	€. 97,20
			C	299	36,5	871149973	€. 99,90

RACCORDI PORTAGOMMA IN POLIPROPILENE VEDI PAG. 43
POLYPROPYLENE PIPE FITTINGS SEE PAGE 43



FILTRO ASPIRAZIONE IN POLIPROPILENE CON CAPACITA' FILTRANTE DA 220 A 260 L/min -
SUCTION FILTER IN POLYPROPYLENE WITH FILTER CAPACITY FROM 220 TO 260 L/min

	MESH	ATTACCO / CONNECTION	TIPO / TYPE	S	H	CODICE / PART NR.	PREZZO / PRICE
	32		A	321	36,5	871157973	€ 70,20
			B	346	36,5	871158973	€ 99,90
			C	384	36,5	871159973	€ 102,60

RACCORDI PORTAGOMMA IN POLIPROPILENE VEDI PAG. 43
POLYPROPYLENE PIPE FITTINGS SEE PAGE 43

RACCORDI PORTAGOMMA IN POLIPROPILENE PER FILTRI
POLYPROPYLENE PIPE FITTINGS FOR FILTERS

FILETTO THREAD	Ø CENTRAGGIO CENTERING	Ø TUBO HOSE Dia.	CODICE - PART NR.	PREZZO - PRICE	CODICE - PART NR.	PREZZO - PRICE
G. 1"1/4	32	25	253047973	€. 14,85	253045973	€. 16,20
		30	253048973	€. 14,85	253046973	€. 16,20
		32	245342973	€. 16,20	245381973	€. 16,20
G. 1"1/2	38	25	245343973	€. 14,85	245344973	€. 14,85
		30	245110973	€. 14,85	245111973	€. 16,20
		32	245366973	€. 14,85	245382973	€. 16,20
		35	245367973	€. 16,20	245383973	€. 16,20
		38	245368973	€. 16,20	245384973	€. 16,20
		40	245112973	€. 16,20	245113973	€. 16,20
G. 2"	48	40	245369973	€. 16,20	245387973	€. 20,25
		45	245370973	€. 17,55	245388973	€. 20,25
		50	245371973	€. 17,55	245389973	€. 21,20
G. 2"1/2	63,5	60			149922973	€. 21,20

CARTUCCE FILTRI ASPIRAZIONE
CARTRIDGES FOR SUCTION FILTERS

Colore Color	MESH	Capacità filtrante del filtro (l/min) - Filtering capacity (L/min)							
		120		100÷160		160÷200		200÷260	
		CODICE - PART NR.	PREZZO - PRICE	CODICE - PART NR.	PREZZO - PRICE	CODICE - PART NR.	PREZZO - PRICE	CODICE - PART NR.	PREZZO - PRICE
ROSSO RED	32	870060322	Consultar	870061322	Consultar	870062322	Consultar	870063322	Consultar
BLU BLUE	50	870064322	Consultar	870065322	Consultar	870066322	Consultar	870067322	Consultar
GIALLO YELLOW	80	870068322	Consultar	870069322	Consultar	870070322	Consultar	870071322	Consultar
O-RING (2 X CARTUCCIA- CARTRIDGE)		803210632	Consultar	803210632	Consultar	803210862	Consultar	803210862	Consultar

NOTA: I FILTRI BERTOLINI VENGONO FORNITI CON CARTUCCE 32 MESH DI SERIE PERCHE' GARANTISCONO IL FUNZIONAMENTO DELLE POMPE IN CONDIZIONI OTTIMALI. VALORI DI FILTRAZIONE DIFFERENTI POSSONO ESSERE UTILIZZATI SOLO IN CASI ECCEZIONALI PER APPLICAZIONI PARTICOLARI

NOTE: BERTOLINI FILTERS ARE SUPPLIED STANDARD WITH 32 MESH CARTRIDGE TO ENSURE BEST CONDITIONS OF WORK TO THE PUMP. DIFFERENT FILTERING CAPACITY CAN BE USED ONLY FOR SPECIAL APPLICATIONS IN EXCEPTIONAL CASES.



FILTRO DI MANDATA IN POLIPROPILENE CON CAPACITA' FILTRANTE FINO A 80 L/min -
LINE FILTER IN POLYPROPYLENE WITH FILTER CAPACITY UP TO 80 L/min



MESH	ATTACCO CONNECTION	CODICE PART NR.	PREZZO PRICE
50	BAIONETTA RELEASE PIN	871170973	€. 24,30
80		871171973	€. 24,30

ACCESSORI PER FILTRI IN LINEA

ACCESSORIES FOR LINE FILTERS



KIT PORTAGOMMA DRITTI - STRAIGHT HOSE TAIL KITS

KIT PORTAGOMMA 90° - 90° HOSE TAIL KITS

DESCRIZIONE DESCRIPTION	CODICE PART NR.	PREZZO PRICE
KIT RACCORDO CON OR Ø 10 MM. THREADED FITTING KIT WITH O-RING Ø 10MM	259940973	€. 8,10
KIT RACCORDO CON OR Ø 13 MM. THREADED FITTING KIT WITH O-RING Ø 13MM	259950973	€. 8,10
KIT RACCORDO CON OR Ø 16 MM. THREADED FITTING KIT WITH O-RING Ø 16MM	259951973	€. 8,10
KIT RACCORDO CON OR Ø 20 MM. THREADED FITTING KIT WITH O-RING Ø 20MM	259952973	€. 8,10
KIT RACCORDO CON OR Ø 3/4 NPTF THREADED FITTING KIT WITH O-RING Ø 3/4 NPTF	259953973	€. 10,80
KIT RACCORDO CON OR G. 1" M THREADED FITTING KIT WITH O-RING G. 1" M	258157973	€. 17,50

DESCRIZIONE DESCRIPTION	CODICE PART NR.	PREZZO PRICE
KIT RACCORDO CON OR Ø 10 MM. - 90° THREADED FITTING KIT WITH O-RING Ø 10MM-90°	259713973	€. 8,10
KIT RACCORDO CON OR Ø 13 MM. - 90° THREADED FITTING KIT WITH O-RING Ø 13 MM-90°	259714973	€. 8,10
KIT RACCORDO CON OR Ø 16 MM. - 90° THREADED FITTING KIT WITH O-RING Ø 16MM-90°	259715973	€. 8,10
KIT RACCORDO CON OR Ø 20 MM. - 90° THREADED FITTING KIT WITH O-RING Ø 20MM-90°	259716973	€. 8,10



CARTUCCE FILTRI DI MANDATA
CARTRIDGES FOR LINE FILTERS

Colore Color	MESH	CODICE - PART NR.	PREZZO - PRICE
BLU BLUE	50	870072322	Consultar
GIALLO YELLOW	80	870073322	Consultar

AGITATORI IDRAULICI

HYDRAULIC AGITATORS



Diametro ugello Nozzle dia.	Ingresso	CODICE PART NR.	PREZZO - PRICE	Diametro ugello Nozzle dia.	Ingresso	CODICE PART NR.	PREZZO - PRICE
1.2	0°	871000973	€. 14,85	1.2	90°	871003973	€. 16,20
1.5		871001973	€. 14,85	1.5		871004973	€. 16,20
2		871002973	€. 14,85	2		871005973	€. 16,20

	DESCRIZIONE DESCRIPTION	CODICE PART NR.	PREZZO PRICE
	LANCIA A LEVA LEVER SPRAY GUN mm. 300 mm. 300	846607002	€. 43,20
	LANCIA A LEVA LEVER SPRAY GUN mm. 600 mm. 600	846606002	€. 67,50
	LANCIA A LEVA LEVER SPRAY GUN mm. 1.000 mm. 1.000	846611002	€. 75,60
	LANCIA A MANOPOLA HANDLE SPRAY GUN mm. 300 mm. 300	846609002	€. 63,45
	LANCIA A MANOPOLA HANDLE SPRAY GUN mm. 600 mm. 600	846612002	€. 70,70
	LANCIA A MANOPOLA HANDLE SPRAY GUN mm. 1.000 mm. 1.000	846608002	€. 76,95
	LANCIA A MITRA SEMPLICE SPRAY GUN WITH ONE ADJUSTMENT KIT RICAMBI LANCIA SEMPLICE	846603002 846743002	€. 121,50 Consultar
	LANCIA A MITRA DOPPIA SPRAY GUN WITH TWO ADJUSTMENTS KIT RICAMBI LANCIA DOPPIA	846604002 846744002	€. 194,40 Consultar
	LANCIA MINIMITRA MINIMITRA SPRAY GUN	846614002	€. 91,80
	LANCIA A PISTOLA SPRAY GUN	846613002	€. 118,80
	LANCIA TIPO LUNGO INOX (40 BAR) STAINLESS STEEL SPRAY GUN LONG TYPE (40 BAR)	846629002	€. 54,00

UGELLI PER LANCIA - NOZZLES FOR SPRAY GUN

BUSSOLA IN WIDIA - WIDIA BUSH



Ø mm.	CODICE - PART NR.	PREZZO - PRICE
1,5	846654002	€ 12,15
1,8	846656002	€ 12,15
2	846657002	€ 12,15
2,5	846660002	€ 12,15
3	846663002	€ 12,15
3,5	846664002	€ 17,55
4	846665002	€ 27,00

BUSSOLA IN WIDIA A VENTAGLIO - WIDIA FLAT SPRAY BUSH



Ø mm.	CODICE - PART NR.	PREZZO - PRICE
1	846652402	€ 16,20
1,2	846653502	€ 16,20
1,5	846654502	€ 16,20
1,8	846656502	€ 16,20
2	846657502	€ 16,20
2,5	846657202	€ 16,20

BUSSOLA IN CERAMICA - CERAMIC BUSH



Ø mm.	CODICE - PART NR.	PREZZO - PRICE
1,5	846667502 con inserto in ceramica	€ 43,20
1,8	846668502 con inserto in ceramica	€ 43,20
2	846669002	€ 13,50
2,5	846669502	€ 14,85
3	846670502	€ 14,85
3,5	846671002	€ 14,85
4	846671502	€ 14,85

ACCESSORI PER LANCE - SPRAY GUNS ACCESSORIES



PORTAGOMMA CON GIRELLO - HOSETAIL WITH FLY NUT
VEDI PAG. 36
SEE PAGE 34



TESTINE IRRORANTI - SPRAYING GUN HEADS



TIPO - TYPE	CODICE - PART NR.	PREZZO - PRICE
2 VIE/2 WAYS	846628002	€ 36,45
3 VIE/3 WAYS	846629002	€ 54,00
PROTEZIONE / PROTECTION	846623002	€ 18,90



TESTINE ESAGONALI ACCIAIO - HEXAGONAL SPRAYING HEADS (STEEL)

Ø mm.	CODICE - PART NR.	PREZZO - PRICE
1	846659502	€ 6,75
1,2	846660502	€ 6,75
1,5	846651502	€ 6,75
2	846663502	€ 6,75
2,5	846664502	€ 6,75
3	846666502	€ 6,75

Legenda Valvole
Index of valves type

Tipo – Type	Descrizione - Description
VS	Valvola di massima pressione Pressure relief valve
VGM - VGE	Valvola generale (manuale/motorizzata) Main ON-OFF valve (manual/motorpowered)
VPBPM - VPBPE	Valvola regolazione pressione proporzionale bassa pressione (manuale/motorizzata) Volumetric valve low pressure (manual/motorpowered)
VPAPM - VPAPE	Valvola regolazione pressione proporzionale alta pressione (manuale/motorizzata) Volumetric valve high pressure (manual/motorpowered)
VPBPS	Valvola di massima pressione con valvola proporzionale integrata Pressure relief valve with integrated volumetric valve
RSM - RSE	Valvola di sezione semplice effetto (manuale/motorizzata) Section valve simple acting (manual/motorpowered)
RDM - RDE	Valvola di sezione doppio effetto (manuale/motorizzata) Metered by-pass section valve (manual/motorpowered)
LP	Versione bassa pressione (20 bar) Low pressure version (20 bar)
HP	Versione alta pressione (40 bar) High pressure version (40 bar)
 S5	Attacco modulare Serie 5 Modular connection "5-Series"
 T5	Attacco rapido a baionetta Serie 5 Quick connection "5-Series"

Sistema di connessione rapida a baionetta che velocizza l'installazione degli accessori nei gruppi comando **bassa pressione (20 bar)**. Connessioni compatibili con prodotti Arag, Geoline e Polmac
Quick bayonet connection system that speeds up the installation of accessories in **low pressure control units (20 bar)**. Connections compatible with Arag, Geoline and Polmac products

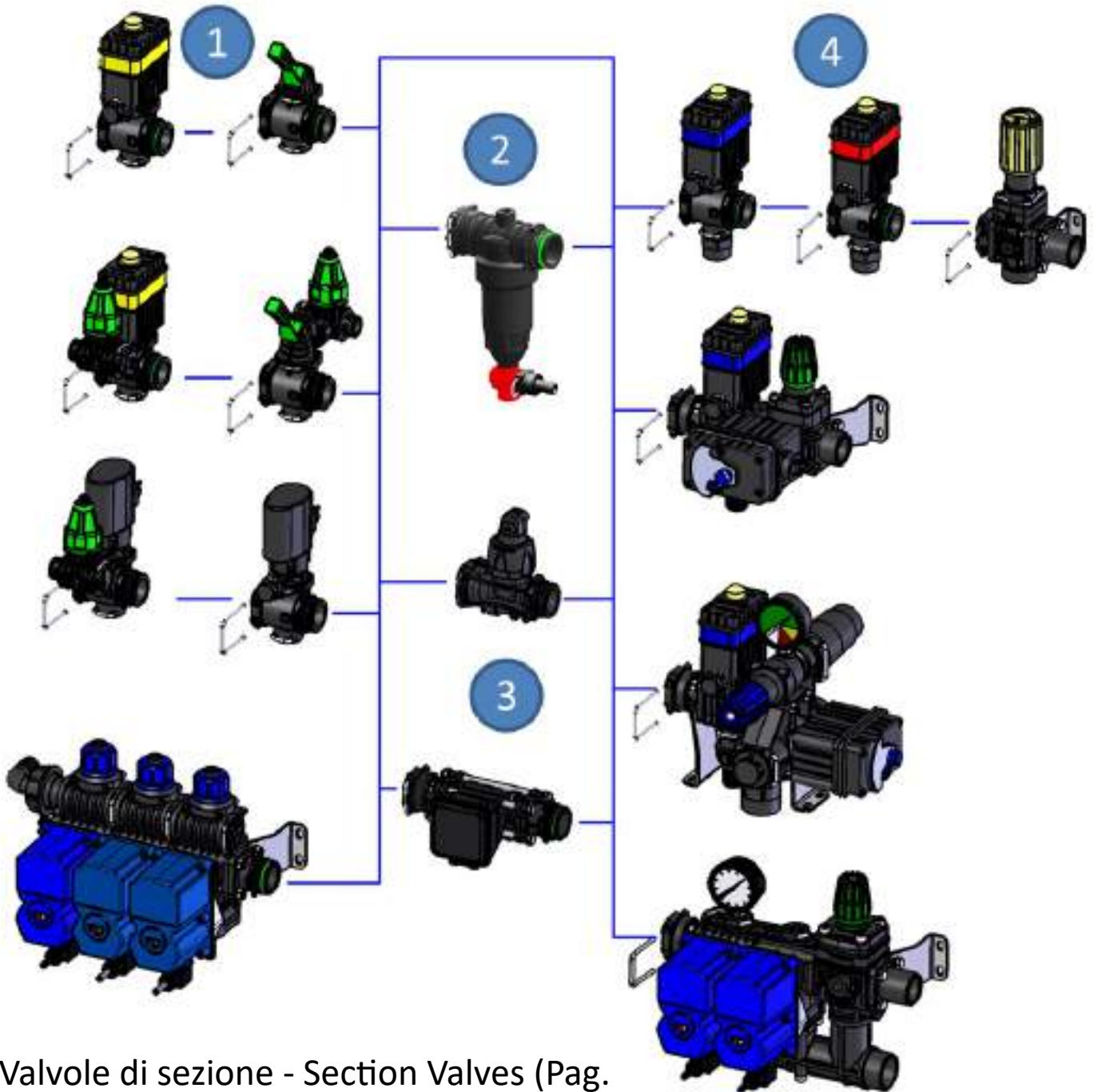

1-Valvole di sezione - Section Valves (Pag. 47)

2-Filtri - Filters (Pag. 49)

3-Flussometri - Flowmeters (Pag. 49)

4-Gruppi regolazione - Regulation Groups (Pag. 50-53)



ESEMPIO CONFIGURAZIONE MONO BLOCCO

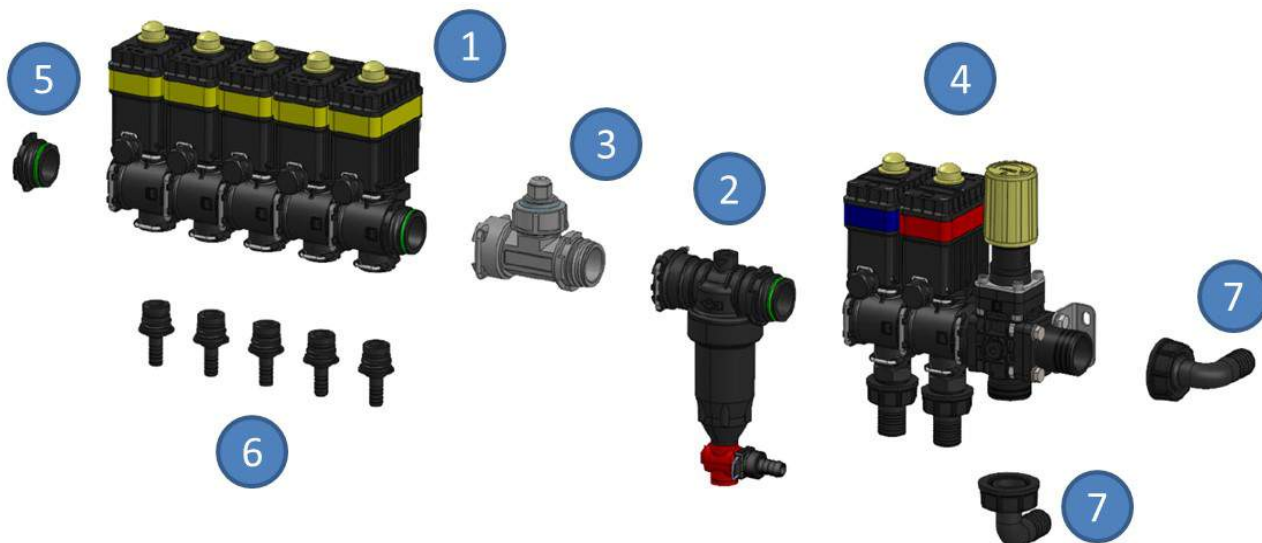

Componenti di base				
Rif.	Descrizione Description	Q.tà Q.ty	Codice Part Nr.	Pag.
1	Valvola di sezione RSE	N	259804973S5	47
2	Filtro 160 L/min 80 mesh	1	795006973T5	49
3	Flussometro a turbina	1	828500973T5	49
4	Gr. reg. Ecocontrol	1	25814097AS5 *	53
5	Kit tappo	1	253053973S5	51
* In alternativa: VS 25.9721.97.3S5 + VGE 25.8650.97.3S5 + VPBPE 25.8652.97.3S5				50

Componenti di completamento				
Rif.	Descrizione Description	Q.tà Q.ty	Codice Part Nr.	Pag.
6	Kit portagomma	N	259714973	52
7	Portagomma	2	253045973	57

ESEMPIO CONFIGURAZIONE INDIPENDENTE



Componenti di base				
Rif.	Descrizione Description	Q.tà Q.ty	Codice Part Nr.	Pag.
1	Valvola di sezione RD 0,6 Sec.	N	796001973S5	47
2	Filtro 260 L/min 100 mesh	1	795013973T5	49
3	Flussometro elettromagnetico	1	828502973T5	49
4	Gr. reg. Multicontrol	1	258142973T5	53
5	Kit porta manometro	1	253055973S5	51

Componenti di completamento				
Rif.	Descrizione Description	Q.tà Q.ty	Codice Part Nr.	Pag.
6	Manometro	1	830010112	52
7	Kit completamento RD	1	253068973	52
8	Kit portagomma	N	259714973	52
9	Kit ingresso set valv.	1	253063973S5	51
10	Kit uscita Gr. reg.	1	253060973S5	58
11	Kit ingresso e By-pass	1	252530973	57



ESEMPIO CONFIGURAZIONE MONO BLOCCO CON INGRESSO SUL GRUPPO REGOLAZIONE

Installazione standard

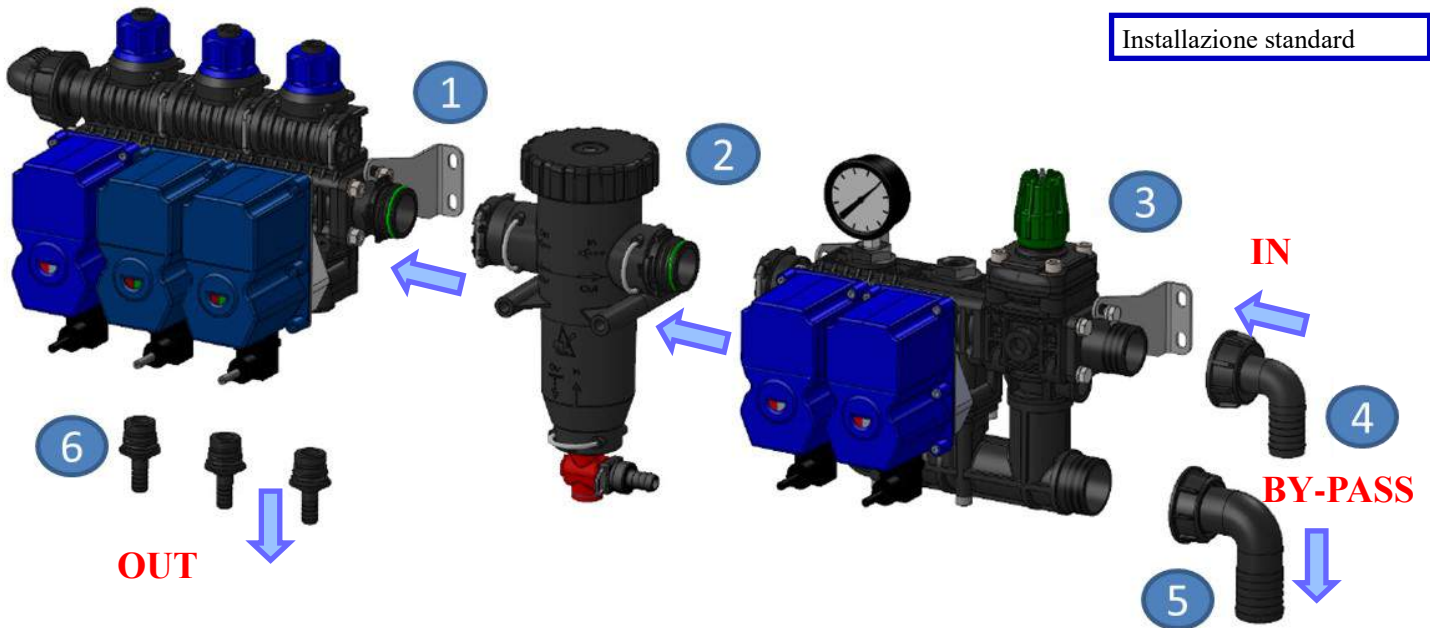

Componenti di base				
Rif.	Descrizione Description	Q.tà Q.ty	Codice Part Nr.	Pag.
1	Valvola di sezione RD .	N	245308973T5	48
2	Filtro 260 L/min 80 mesh	1	795012973T5	49
3	Gr. reg. Viking	1	245282973T5	54

Componenti di completamento				
Rif.	Descrizione Description	Q.tà Q.ty	Codice Part Nr.	Pag.
4	Kit portagomma ingresso	1	253046973	58
5	Kit portagomma By- pass	1	245113973	58
6	Kit portagomma	N	259714973	52

ESEMPIO CONFIGURAZIONE MONO BLOCCO CON INGRESSO SUL FILTRO

Installazione fattibile solo
con gruppi regolazione
Ecocontrol e Viking

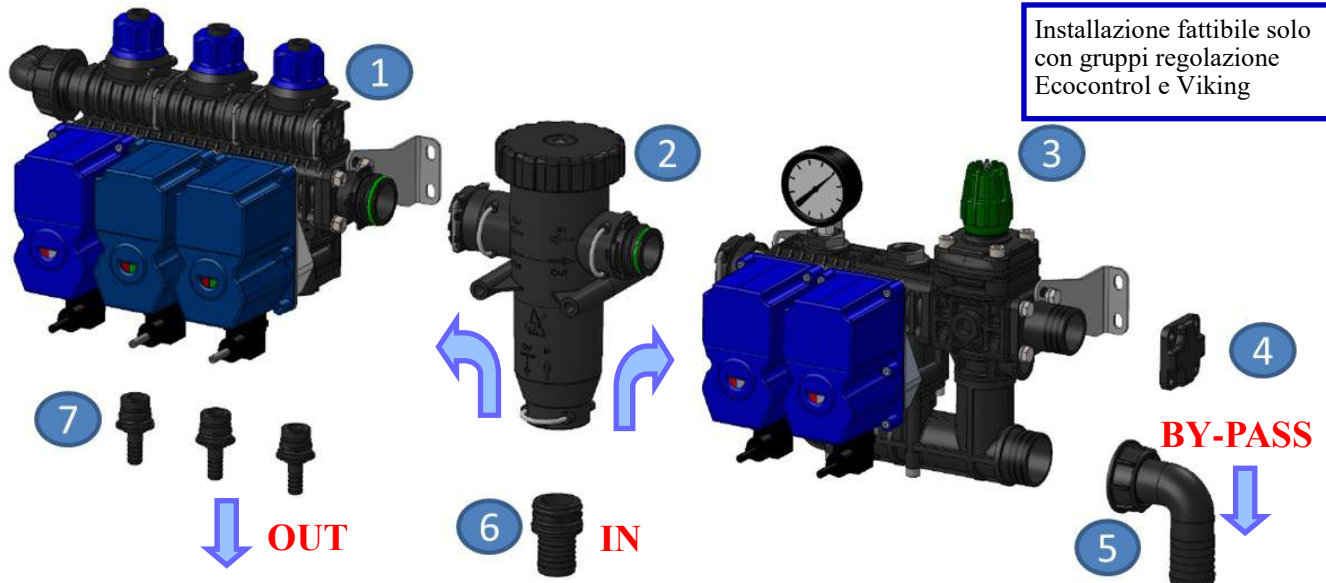







Componenti di base				
Rif.	Descrizione Description	Q.tà Q.ty	Codice Part Nr.	Pag.
1	Valvola di sezione RD .	N	245308973T5	48
2	Filtro 260 L/min 80 mesh	1	795012973T5	49
3	Gr. reg. Viking	1	245282973T5	54



Componenti di completamento				
Rif.	Descrizione Description	Q.tà Q.ty	Codice Part Nr.	Pag.
4	Flangia/tappo chiusura	1	250051322	49
5	Kit portagomma By- pass	1	245113973	58
6	Kit portagomma ingresso	1	04581	su richiesta
7	Kit portagomma	N	259714973	52

1

MODULI DI COMPOSIZIONE
COMPOSITION MODULES
BERTOLINI
pumps
SERIE S5
NEW

		VALVOLE DI SEZIONE (SEMPLICE EFFETTO)		SECTION VALVES (SIMPLE ACTING)	
		COMPONENTE PART	BAR	CODICE PART NR.	PREZZO PRICE
 RSM	 RSE	RSM blu RSM blue	20	259803973S5	€ 28,35
		RSM verde RSM green	20	259804973S5	€ 28,35
		RSE	20	258122973S5	€ 202,50

		VALVOLE DI SEZIONE (DOPPIO EFFETTO)		METERED BY-PASS SECTION VALVES	
		COMPONENTE PART	BAR	CODICE PART NR.	PREZZO PRICE
VERSIONE INTERMEDIA - MODULAR VERSION					
 RDM	 RDE	RDM blu RDM blue	20	25980597AS5	€ 49,95
		RDM verde RDM green	20	25980697AS5	€ 49,95
		RDE blu RDE blue	20	25994597BS5	€ 214,65
		RDE verde RDE green	20	25812397AS5	€ 214,65
VERSIONE TERMINALE - THREADED OUTLET FOR COUPLING TO THE BY-PASS HOSE FITTING					
 RDM	 RDE	RDM blu RDM blue	20	25809997AS5	€ 59,40
		RDM verde RDM green	20	25812197AS5	€ 59,40
		RDE blu RDE blue	20	25820497AS5	€ 221,40
		RDE verde RDE green	20	25812497AS5	€ 221,40

		VALVOLE DI SEZIONE VELOCI		FAST SECTION VALVES	
		COMPONENTE PART	BAR	CODICE PART NR.	PREZZO PRICE
 RSE	 RDE	RSE	20	796000973S5	€ 260,55
		RDE verde RDE green	20	796001973S5	€ 260,55

0.6 sec

Dimensioni raccordi (NON INCLUSI)- Pipe fittings (NOT INCLUDED)

10-13-16-20-3/4-NPT.F-G.1" M-G.1/2" M

1

**GRUPPI VALVOLE DI SEZIONE
SECTION VALVES ASSEMBLIES**



SERIE S5-T5



RDE



RSE

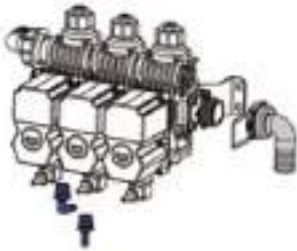

MOD.	Nr.	COD. - Part Number	Prezzo - Price
RDE	2	245800973T5	€. 800,55
	3	245308973T5	€. 1.162,35
	4	245309973T5	€. 1.530,90
	5	245310973T5	€. 1.900,80
	6	245311973T5	€. 2.277,45
	7	245312973T5	€. 2.656,80

MOD.	Nr.	COD. - Part Number	Prezzo - Price
RSE	2	245472973T5	€. 720,90
	3	245303973T5	€. 1.043,55
	4	245304973T5	€. 1.370,25
	5	245305973T5	€. 1.683,45
	6	245306973T5	€. 2.018,25
	7	245307973T5	€. 2.343,60

DIMENSIONI RACCORDI - PIPE FITTINGS	
T5	PTG. D. 30-90° Hosetails dia. 30-90°



2

FILTRI AUTOPULENTI - SELF-CLEANING FILTERS



Max		Mesh	Serie 5 M-F	Prezzo - Price
L/min.	USGPM			
160	42	50	819043973T5	€ 49,95
		80	819042973T5	€ 49,95
280	74	50	819041973T5	€ 74,25
		80	819040973T5	€ 74,25

2

FILTRI AUTOPULENTI AD ALTA EFFICIENZA - HIGH EFFICIENCY SELF-CLEANING FILTERS

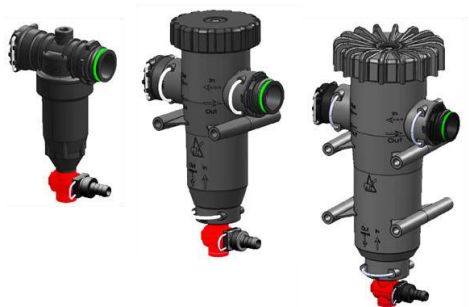

Max		Mesh	Serie 5 M-F	Prezzo - Price
L/min.	USGPM			
160	42	50	795005973T5	€ 86,40
		80	795006973T5	€ 86,40
		100	795007973T5	€ 86,40
260	57.2	50	795011973T5	€ 97,20
		80	795012973T5	€ 97,20
		100	795013973T5	€ 97,20
500	110	50	795015973T5	€ 121,50
		80	795016973T5	€ 121,50
		100	795017973T5	€ 121,50



Componenti per conversione filtri 260-500 L/min e gruppi regolazione con ingresso sul filtro (schema 2 pag. 46)

Componente	Impiego		COD. - Part Number	Prezzo - Price
Raccordo (x filtro)	260 L/min	33	04581	Su richiesta
	500 L/min	40	22040	Su richiesta
Flangia	Viking	/	250051322	€ 4,73
Tappo	Ecocontrol	/	253054973S5	€ 8,10

3

FLUSSOMETRI - FLOW METERS





			Serie 5 M-F	Prezzo - Price
Bar	Psi			
20	290	10÷100	828500973T5	€ 587,25
		35÷350	828501973T5	€ 650,70
50	725	10÷200	828502973T5	€ 992,25



VALVOLE DI REGOLAZIONE E DI SEZIONE

VALVOLE DI MASSIMA PRESSIONE PRESSURE RELIEF VALVES						
COMPONENTE PART	BAR	IN	OUT	CODICE PART NR.	PREZZO PRICE	
	20	1" 1/4	T5F	259721973S5	€ 144,45	
		1"	T5F	259722973S5	€ 144,45	
		T5F	T5F	259723973S5	€ 148,50	

VALVOLE GENERALI - MAIN VALVES				
COMPONENTE PART	BAR	CODICE PART NR.	PREZZO PRICE	
	VGM	20	258120973S5	€ 32,40
	VGE	20	258650973S5	€ 209,25

VALVOLE DI REGOLAZIONE PRESSIONE PROPORZIONALE PROPORTIONAL PRESSURE REGULATING VALVES				
COMPONENTE PART	BAR	CODICE PART NR.	PREZZO PRICE	
	VPBPM	20	DESCATALOGADO	
	VPBPE 5 Sec.	20	258651973S5	€ 203,85
	VPBPE 9 Sec.	20	258652973S5	€ 221,40
	VPBPE 21 Sec.	20	258653973S5	€ 226,80



Dimensioni raccordi (NON INCLUSI)- Pipe fittings (NOT INCLUDED)

25



PER MODULI DI COMPOSIZIONE 1-4
FOR COMPOSITION MODULES 1-4

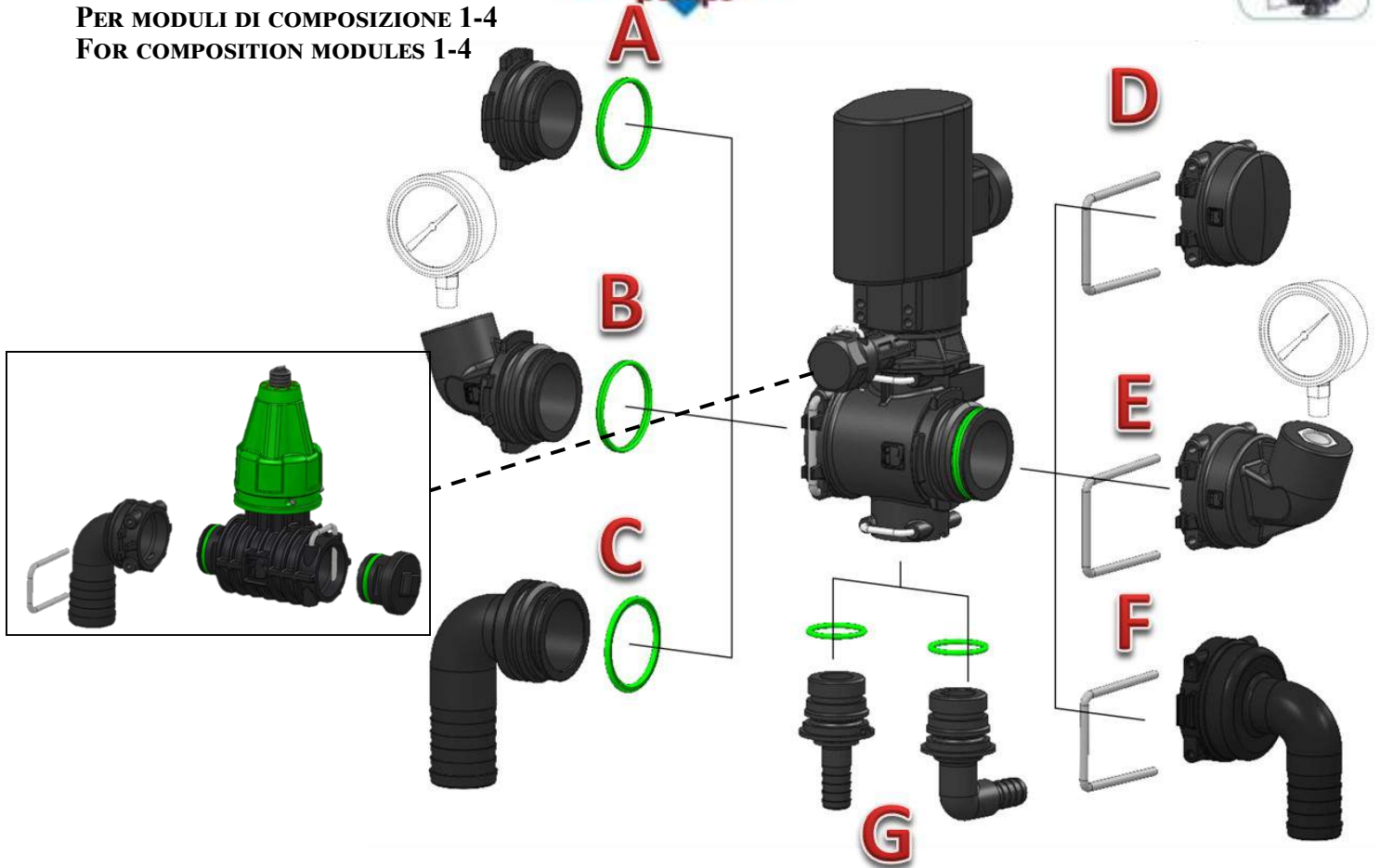

KIT TAPPI - PLUGS KIT



Mod. - Mod	Codice. - Part Number	Prezzo - Price
Maschio/Male	253053973S5	€. 6,75
Femmina/Female	253054973S5	€. 8,10



KIT PORTA MANOMETRO - PRESSURE GAUGE HOLDER KIT

Mod. - Mod	Codice. - Part Number	Prezzo - Price
Maschio/Male - G. 1/4" F	253055973S5	€. 9,45
Femmina/Female - G. 1/4" F	253056973S5	€. 10,80



KIT PORTAGOMMA - HOSE TAILS KITS

Mod. - Mod		Codice. - Part Number	Prezzo - Price
Maschio / Male	25	253060973S5	€. 8,10
	30	253061973S5	€. 8,10
	32	253062973S5	€. 8,10
Femmina / Female	25	253063973S5	€. 8,10
	30	253064973S5	€. 8,10
	32	253065973S5	€. 8,10





**PER MODULI DI COMPOSIZIONE 1-4
FOR COMPOSITION MODULES 1-4**

G



VALVOLE DI SEZIONE - SECTION VALVES							
Impiego Use			mm	Cod. - Part Nr.	Prezzo Price	Cod. - Part Nr.	Prezzo Price
	Bar	Psi					
Ecocontrol Multicontrol Nergydrops Viking	20	290	10	259940973	€. 8,10	259713973	€. 8,10
			13	259950973	€. 8,10	259714973	€. 8,10
			16	259951973	€. 8,10	259715973	€. 8,10
			20	259952973	€. 8,10	259716973	€. 8,10
			3/4 NPT.F	259953973	€. 10,80		
			G.1" M	258157973	€. 17,55		
			G.1/2" M	259704973	€. 32,40		

G



H



BY-PASS VALVOLE GENERALI E VALVOLE PROPORZIONALI MAIN VALVES AND PROPORTIONAL VALVES BY-PASS				
	Cod. - Part Nr.	Prezzo - Price		Mod.
G.1"	255151973	€. 8,10	25mm 1"	
	255152973	€. 8,10		

KIT COMPLETAMENTO RD RD COMPLETION KIT	
Codice. - Part Number	Prezzo - Price
253068973	€. 8,10



MANOMETRI PRESSURE GAUGES				
COMPONENTE			Cod. - Part Nr.	Prezzo - Price
PART	ABS	RAD.	830010112	€. 20,25
		POST.	830010122	€. 20,25
0-16	INOX	RAD.	830007002	€. 40,50
		POST.	830008002	€. 40,50
0-5-24	INOX	RAD.	830001502	€. 81,00
		POST.	830001602	€. 109,35



GRUPPI REGOLAZIONE ECOCONTROL - ECOCONTROL REGULATING UNITS



VPBPM	VPBPE	COD. - Part Nr.	PREZZO - Price
GRUPPI MANUALI - MANUAL UNITS			
•	/	25813997AS5	€. 237,60
GRUPPI MOTORIZZATI - MOTOR POWERED UNITS			
/	5 Sec.	258402973S5	€. 554,85
/	9 Sec.	25814097AS5	€. 572,40
/	21 Sec.	25840497AS5	€. 577,80

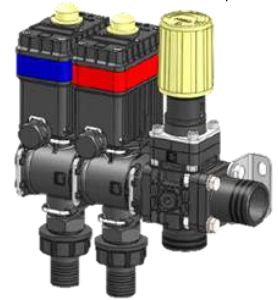

VGE	VPBPE	COD. - Part Nr.	PREZZO - Price
GRUPPI MOTORIZZATI - MOTOR POWERED UNITS			
/	9 Sec.	258447973S5	€. 383,50



Dimensione raccordi - Pipe fittings			
IN	By-pass		OUT
G.1"1/4	VS	VG-VPBP	S5
	G1"1/4	G1"	

GRUPPI REGOLAZIONE MULTICONTROL - MULTICONTROL REGULATING UNITS



VPBP	2 RS (OUT D.16)	COD. - Part Nr.	PREZZO - Price
GRUPPI MANUALI - MANUAL UNITS			
/	/	251420973T5	€. 139,05
•	/	258141973T5	€. 199,80
•	•	258450973T5	€. 286,20
GRUPPI MOTORIZZATI - MOTOR POWERED UNITS			
5 Sec.	/	258451973T5	€. 558,90
	•	258452973T5	€. 626,40
9 Sec.	/	258142973T5	€. 573,75
	•	258453973T5	€. 645,30
21 Sec.	/	258454973T5	€. 581,85
	•	258455973T5	€. 650,70



Dimensione raccordi - Pipe fittings				
IN	OUT	By-Pass		
		VS	VG	VPBP
G. 1"	T5	G. 1"1/4		Ptg. D.25 mm Hosetails dia. 25



GRUPPI REGOLAZIONE NERGYDROP - NERGYDROP REGULATING UNITS

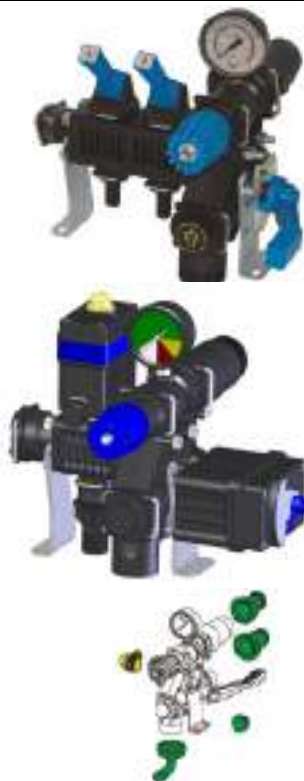

VPBP	2 RS (OUT D.16)	COD. - Part Number	Prezzo - Price
GRUPPI MANUALI - MANUAL UNITS			
•	/	258324973T5	€. 202,50
•	•	258500973T5	€. 299,70
GRUPPI AD AZIONAMENTO ELETTRICO - MOTOR POWERED UNITS			
5 Sec.	/	258501973T5	€. 584,55
	•	258502973T5	€. 653,40
9 Sec.	/	25181997AT5	€. 602,10
	•	258503973T5	€. 670,95
21 Sec.	/	258504973T5	€. 607,50
	•	258505973T5	€. 676,35

Dimensione raccordi - Pipe fittings				
IN	OUT	By-Pass		
		VS	VG	VPBP
G. 1"1/2	T5	G. 1"1/2		Ptg. D.25 mm Hosetails dia. 25

GRUPPI REGOLAZIONE VIKING - VIKING REGULATING UNITS



VPBP	RS (OUT D.16)	COD. - Part Number	Prezzo - Price
7 Sec.	/	245801973T5	€. 1.070,55
	N° 1	245802973T5	€. 1.154,25
	N° 2	245803973T5	€. 1.240,65
13 Sec.	/	245282973T5	€. 1.069,20
	N° 1	245276973T5	€. 1.154,25
	N° 2	245278973T5	€. 1.242,00
30 Sec.	/	245316973T5	€. 1.059,75
	N° 1	245322973T5	€. 1.142,10
	N° 2	245324973T5	€. 1.224,45



Dimensioni raccordi - Pipe fittings				
IN	OUT	By-pass		
		VS	VG	VPBP
G.1"1/4	T5	G.1"1/2		



**ESEMPI GRUPPI
PRE-MONTATI**



GRUPPI VALVOLE DI SEZIONE AD AZIONAMENTO MANUALE
MANUAL SECTION VALVES ASSEMBLIES





TIPO - TYPE 	NR.	COD. - Part Number	Prezzo - Price
SENZA BY-PASS CALIBRATO WITHOUT METERED BY-PASS	3	251980973S5	€. 82,35
	4	251981973S5	€. 112,05
	5	251982973S5	€. 139,05
	6	251983973S5	€. 167,40
	7	251984973S5	€. 195,75
CON BY-PASS CALIBRATO WITH METERED BY-PASS	3	25199097AS5	Consultar
	4	25199197AS5	€. 217,35
	5	25199297AS5	€. 265,95
	6	25199397AS5	€. 324,00
	7	25199497AS5	€. 378,00

GRUPPI VALVOLE DI SEZIONE AD AZIONAMENTO ELETTRICO
MOTOR-POWERED SECTION VALVES ASSEMBLIES



TIPO - TYPE	NR. 	COD. - Part Number	Prezzo - Price
SENZA BY-PASS CALIBRATO WITHOUT METERED BY-PASS	3	25200097AS5	€. 606,15
	4	25200197AS5	€. 807,30
	5	25200297AS5	€. 1.007,10
	6	25200397AS5	€. 1.208,25
	7	25200497AS5	€. 1.409,40
CON BY-PASS CALIBRATO WITH METERED BY-PASS	3	25201097BS5	€. 645,30
	4	25201197BS5	€. 854,55
	5	25201297BS5	€. 1.063,80
	6	25201397BS5	€. 1.273,05
	7	25201497BS5	€. 1.485,00



DIMENSIONI RACCORDI - PIPE FITTINGS	
	RD 
T5	PTG. D. 25-90° Hosetails dia. 25-90°



Kit valvole di ricircolo per gruppi Ecocontrol -Multicontrol e Nergydrops motorizzati, studiate per la realizzazione dei circuiti di annullo pressione, antisedimentazione e lavaggio impianti. Sono azionate automaticamente dai motoriduttori di sezione.

Sono indispensabili nel rispetto delle Direttive 2009/127/ CE e 2009/128/CE. Applicabili direttamente anche su gruppi installati precedentemente senza doverli rimuovere dalla macchina.

Valves kits for motor powered units Ecocontrol, Multicontrol and Nergydrops, designed to perform the following functions: bleeding-off pressure, anti sedimentation and washing of the system.

They are automatically operated by section geared motors and they are essential to comply with the European Standards 2009/127/CE and 2009/128/CE about pollution. They can be fitted and retro fitted to all Bertolini control units, without removal from sprayers.



Nr. 	RS		RD	
	Codice - Part Number	Prezzo - Price	Codice - Part Number	Prezzo - Price
3	258608973S5	€. 665,55	258613973S5	€. 704,70
4	258609973S5	€. 865,35	258614973S5	€. 913,95
5	258610973S5	€. 1.066,50	258615973S5	€. 1.123,20
6	258611973S5	€. 1.267,65	258616973S5	€. 1.332,45
7	258612973S5	€. 1.468,80	258617973S5	€. 1.541,70







Nr. 	Codice - Part Number	Prezzo - Price
3	258363973	€. 85,05
4	258364973	€. 105,30
5	258365973	€. 129,60
6	258366973	€. 152,55
7	258367973	€. 178,20



KIT INGRESSO E BY-PASS GRUPPI REGOLAZIONE
INLET AND OUTLET PIPE FITTINGS KITS FOR PRESSURE REGULATING SYSTEMS





ECOCONTROL

	Mod.	Cod. - Part Nr.	Prezzo - Price
25mm 1"		253047973	€. 14,85
		253045973	€. 16,20
30mm 1" 3/16		253043973	€. 6,75
		253046973	€. 16,20













MULTICONTROL

		Cod. - Part Nr.	Prezzo - Price
25mm 90° (1")	19mm (3/4")	251925973	€. 16,20
	19mm (3/4") 90°	251926973	€. 17,55
	25mm (1")	252525973	€. 18,90
	25mm (1") 90°	252526973	€. 18,90
30mm 1" 3/16 90°	25mm (1")	252530973	€. 18,90
	25mm (1") 90°	252531973	€. 27,00



NERGYDROP

			Anti-dripping nozzle	Cod. - Part Nr.	Prezzo - Price	
30-45 L/min 8-12 USGPM	25mm	30mm 1" 3/10		253051973	€. 20,25	
50-75 L/min 13-20 USGPM				253052973	€. 20,25	
80-110 L/min 21-29 USGPM				252532973	€. 20,25	
80-110 L/min 21-29 USGPM		90°	30mm 1" 3/10 40mm 1" 9/16		252533973	€. 32,40
110-160 L/min 29-42 USGPM		1"			252540973	€. 35,10
160-210 L/min 42-55 USGPM		30mm 90° 1" 3/16	40mm		253040973	€. 36,45
210-260 L/min 55-69 USGPM			1" 9/16		253041973	€. 36,45



VIKING

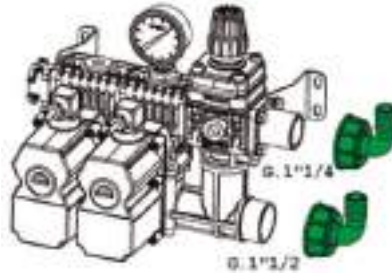

		Mod.	Cod. - Part Nr.	Prezzo - Price			Mod.	Cod. - Part Nr.	Prezzo - Price	
G.1"1/4	25 1"		253047973	€. 11,00	G. 1"1/2	30 1"3/16		245110973	€. 14,85	
			253045973	€. 12,00				245111973	€. 16,20	
	30 1"3/16		253048973	€. 11,00		32 1"1/4		245366973	€. 14,85	
			253046973	€. 12,00				245382973	€. 16,20	
	32 1"1/4		245342973	€. 12,00		35 1"3/8		245367973	€. 16,20	
			245381973	€. 12,00				245383973	€. 16,20	
							38 1"1/2		245368973	€. 16,20
									245384973	€. 16,20
							40 1"9/16		245112973	€. 16,20
									245113973	€. 16,20

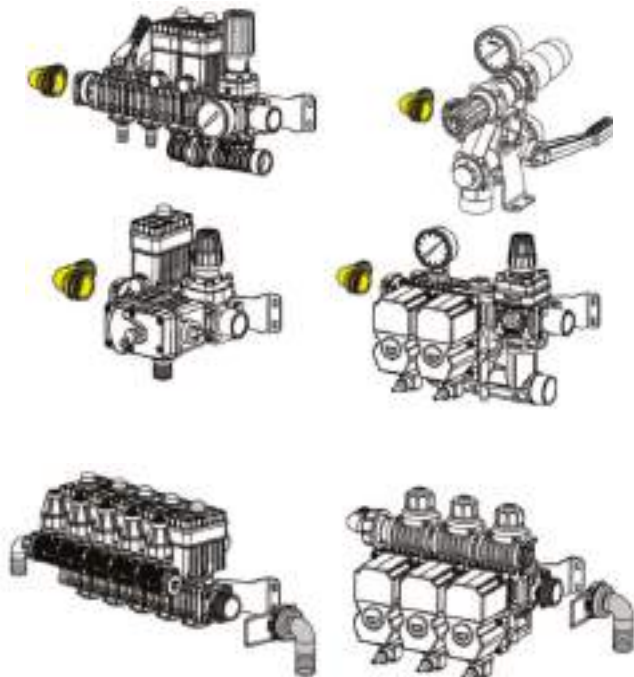

KIT USCITA GRUPPI REGOLAZIONE T5 -
OUTLET KITS FOR CONTROL UNITS T5 SYSTEM

	Mod.	Serie M5	Prezzo - Price
25		253060973S5	€. 8,10
30		253061973S5	€. 8,10
32		253062973S5	€. 8,10

KIT INGRESSO GRUPPI VALVOLE T5 -
INLET KITS FOR VALVES ASSEMBLIES T5 SYSTEM

	Mod.	Serie M5	Prezzo - Price
25		253063973S5	€. 8,10
30		253064973S5	€. 8,10
32		253065973S5	€. 8,10

40
BAR

ECOCONTROL HP

160 L/MIN



GRUPPI DI REGOLAZIONE - REGULATING UNITS				
VG	VPAP	Filtro/Filter	Cod. - Part Number	Prezzo - Price
•	5 Sec.	/	258371973HP	€. 735,75
		•	258372973HP	€. 845,10
/	9 Sec.	/	258432973HP	€. 545,40
•		/	25814097AHP	€. 756,00
		•	25831997AHP	€. 870,75
•		21 Sec.	/	258373973HP
	•		258374973HP	€. 862,65



SET VALVOLE DI SEZIONE HP - H.P. SECTION VALVES ASSEMBLIES					
Senza By-Pass Calibrato Without Metered By-Pass			Con By-Pass Calibrato With Metered By-Pass		
Nr.	Cod. - Part Nr.	Prezzo - Price	Nr.	Cod. - Part Nr.	Prezzo - Price
2	258375973HP	€. 608,85	2	258369973HP	€. 652,05
3	25200097AHP	€. 858,60	3	25201097BHP	€. 916,65
4	25200197AHP	€. 1.107,00	4	25201197BHP	€. 1.182,60
5	25200297AHP	€. 1.358,10	5	25201297BHP	€. 1.448,55
6	25200397AHP	€. 1.605,15	6	25201397BHP	€. 1.714,50



DISTRIBUTORI HP - H.P. CONTROL UNITS						
VG	VPAP	Nr.	Senza By-Pass Calibrato Without Metered By-Pass		Con By-Pass Calibrato With Metered By-Pass	
			Cod.- Part Nr.	Prezzo - Price	Cod.- Part Nr.	Prezzo - Price
/	/	2	258383973HP	€. 731,70	258411973HP	€. 761,40
/	9 Sec.	2	258415973HP	€. 1.013,85	/	
•	9 Sec.	2	258329973HP	€. 1.255,50	258132973HP	€. 1.302,75
		3	258330973HP	€. 1.505,25	258133973HP	€. 1.574,10
		4	258331973HP	€. 1.756,35	258271973HP	€. 1.844,10
		7	/		258273973HP	€. 2.625,75



Dimensioni raccordi - Pipe fittings				
IN	OUT	By-pass		OUT
		VS-VG-VPAP	RD	
G.3/4"	G.3/4"	G.1" 1/4	Ptg D.25-90° - Hosetails dia. 25-90°	G.1/2"

40
BAR

VIKING HP

220 L/MIN

BERTOLINI
pumps

GRUPPI DI REGOLAZIONE - REGULATING UNITS

VPBP	Fitro-Filter	Cod. - Part Number	Prezzo - Price
21 Sec.	/	245313973	€. 1.198,80
5 Sec.	•	245333973	€. 1.325,70

SET VALVOLE DI SEZIONE HP -
H.P. SECTION VALVES ASSEMBLIES

Versione Version RS			Versione Version RD		
Nr.	Cod.- Part Nr.	Prezzo - Price	Nr.	Cod.- Part Nr.	Prezzo - Price
2	245296973	€. 641,00	2	245299973	€. 985,50
3	245297973	€. 924,00	3	245300973	€. 1.420,20
4	245298973	€. 1.203,00	4	245301973	€. 1.853,55

SET VALVOLE DI SEZIONE HP -
H.P. SECTION VALVES ASSEMBLIES





			Versione Version RS		Versione Version RD	
Nr.	VG	VV	Cod.- Part Nr.	Prezzo - Price	Cod.- Part Nr.	Prezzo - Price
2	•	•	245314973	€. 1.945,35	245315973	€. 2.062,80
3	/	/	245417973	€. 1.054,35	245420973	€. 1.198,80
4	/	/	245418973	€. 1.458,00	245421973	€. 1.642,95



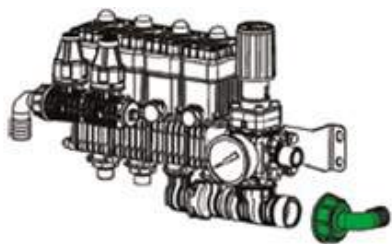







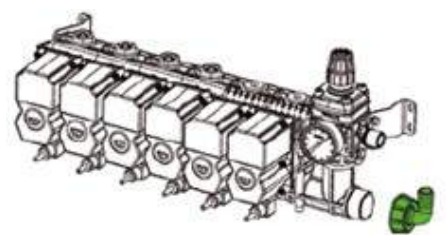



Dimensioni raccordi - Pipe fittings

IN	OUT	By-pass	
		VS-VG-VPBP	RD
G.3/4"	G.3/4"	G.1" 1/2	Ptg D.30-90° - Hosetails dia. 30-90°



		Mod.	Cod. - Part Nr.	Prezzo - Price
G.1"1/4 F	30 1"3/16		253048973	€. 14,85
			253046973	€. 16,20



		Mod.	Cod. - Part Nr.	Prezzo - Price
G.1"1/2	30 1"3/16		245110973	€. 14,85
			245111973	€. 16,20
	32 1"1/4		245366973	€. 14,85
			245382973	€. 16,20
	35 1"3/8		245367973	€. 16,20
			245383973	€. 16,20
	38 1"1/2		245368973	€. 16,20
			245384973	€. 16,20
	40 1"9/16		245112973	€. 16,20
			245113973	€. 16,20



MANOMETRI PRESSURE GAUGES				
COMPONENTE PART			CODICE PART NR.	PREZZO PRICE
0-60	ABS	RAD.	830010132	€. 20,25
		POST.	830010142	€. 20,25
0-100	INOX	RAD.	830089002	€. 40,50
		POST.	830081002	€. 29,70
0-20-40- 60	INOX	RAD.	830002002	€. 83,70
		POST.	830002102	€. 83,70

**VALVOLE A SFERA SUSY
BALL VALVES SUSY**



**VALVOLE A 3 VIE
3 WAY BALL VALVES**

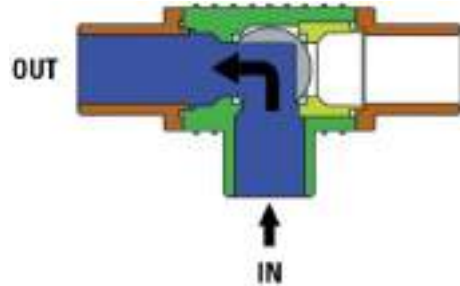
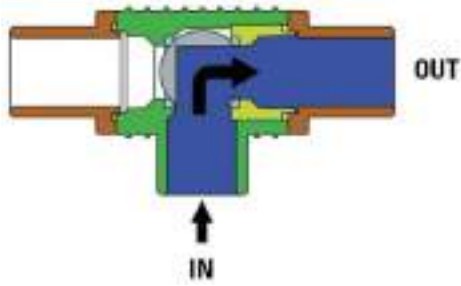

Descrizione Description	Tipo - Type	Codice Part Nr.	Prezzo Price
Valvola "T5" Ball valve "T5"	manuale manual	258605973T5	€. 156,60
	motorizzato motorized	258607973T5	€. 425,25



Tipo - Type	Descrizione Description	Codice Part Nr.	Prezzo Price
Valvola 1"1/4 M Ball valve 1"1/4	manuale manual	258199973	€. 149,85
	motorizzato motorized	258200973	€. 417,15



Tipo - Type	Descrizione Description	Codice Part Nr.	Prezzo Price
Valvola 1" F Ball valve 1" F	manuale manual	258335973	€. 149,85
	motorizzato motorized	258336973	€. 421,20

**VALVOLE A SFERA SUSY
BALL VALVES SUSY**



**VALVOLE A 2 VIE
2 WAY BALL VALVES**

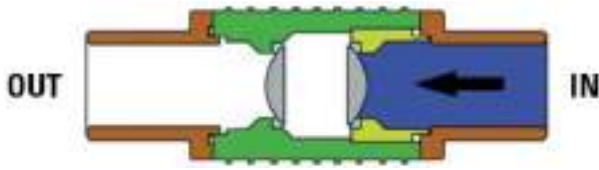

Tipo - Type	Descrizione Description	Codice Part Nr.	Prezzo Price
Valvola "T5" Ball valve "T5"	manuale manual	258604973T5	€. 141,75
	motorizzato motorized	258606973T5	€. 411,75



Tipo - Type	Descrizione Description	Codice Part Nr.	Prezzo Price
Valvola "T5" Ball valve "T5"	manuale manual	258604973T5	€. 141,75
	motorizzato motorized	258606973T5	€. 411,75



Tipo - Type	Descrizione Description	Codice Part Nr.	Prezzo Price
Valvola "T5" Ball valve "T5"	manuale manual	258604973T5	€. 141,75
	motorizzato motorized	258606973T5	€. 411,75

- Computer per macchine da diserbo
- Guida assistita da GPS
- Visualizzazione delle traiettorie di guida
- Chiusura automatica delle sezioni in caso di sovrapposizioni.
- Display da 7" per le indicazioni di guida
- Display da 4,3" per le impostazioni di trattamento.
- Touchscreen
- **Antenna inclusa**



- Computer for crop sprayers.
- GPS assisted guidance.
- Shows the drive path and indication of the paths to follow.
- Automatic shut-off of the section valves when areas are overlapped.
- Display size 7" for drive indications;
- Display size 4,3" for application rate setup.
- Touchscreen
- **GPS antenna included**

Configurazione base per il funzionamento del computer. Per optional vedi pag. 65
Basic configuration for computer operation. For optionals see p. 65

MODELLO MODEL	SEZIONI SECTIONS	CODICE PART NR.	PREZZO PRICE	COMPONENTI COMPONENTS
WSC GPS	5-7 9-11-13	828452973 (ON REQUEST)	€. 5.962,95	1 - 2
CAVI VALVOLE VALVE CABLES	5 7 9 11 13	828107002B 828155002B 828495002B 828496002B 828497002B	€. 240.44 €. 324.95 €. 885.60 €. 924.75 €. 973.35	4
CAVO SENSORI (sensore press./pressure sens. 6 - flussometro/flowmeter 5)		828304002	€. 125,55	3

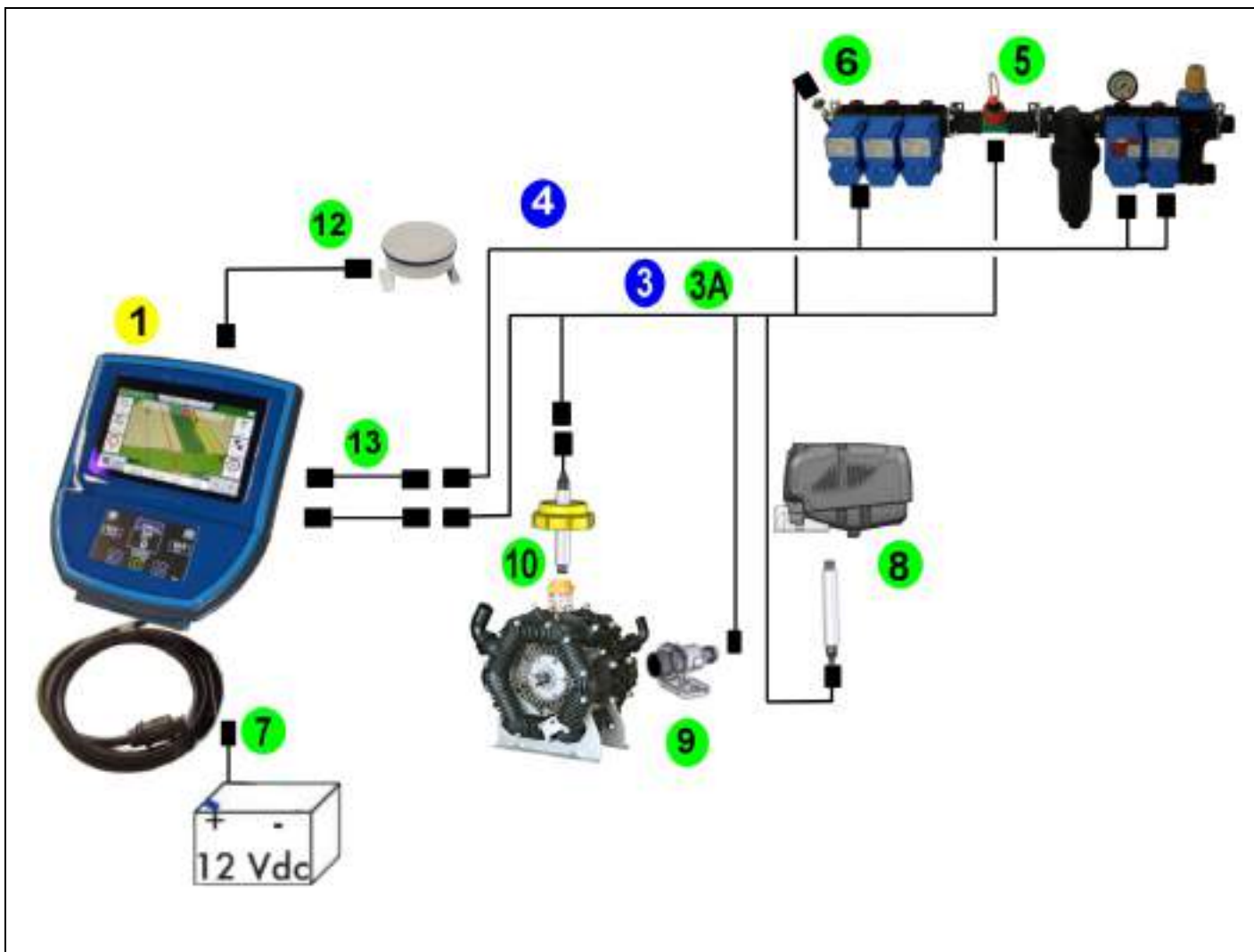

Configurazione base per il funzionamento del computer. Per optional vedi sotto
Basic configuration for computer operation. For optionals see below

MODELLO MODEL	SEZIONI SECTIONS	CODICE PART NR.	PREZZO PRICE	COMPONENTI COMPONENTS
WSC GPS	5-7 9-11-13	828452973 (ON REQUEST)	€ 5.962,95	1 - 2
CAVI VALVOLE VALVE CABLES	5 7 9 11 13	828107002B 828155002B 828495002B 828496002B 828497002B	€ 240,44 € 324,95 € 885,60 € 924,75 € 973,35	4
CAVO SENSORI CABLE TO SENSORS (sensore press./pressure sens. 6 - flussometro/flowmeter 5)		828304002	€ 125,55	3
CAVO VALVOLE OLIO	7 (oil) 9 (oil)	828475002 828474002	€ 529,20 € 618,30	14

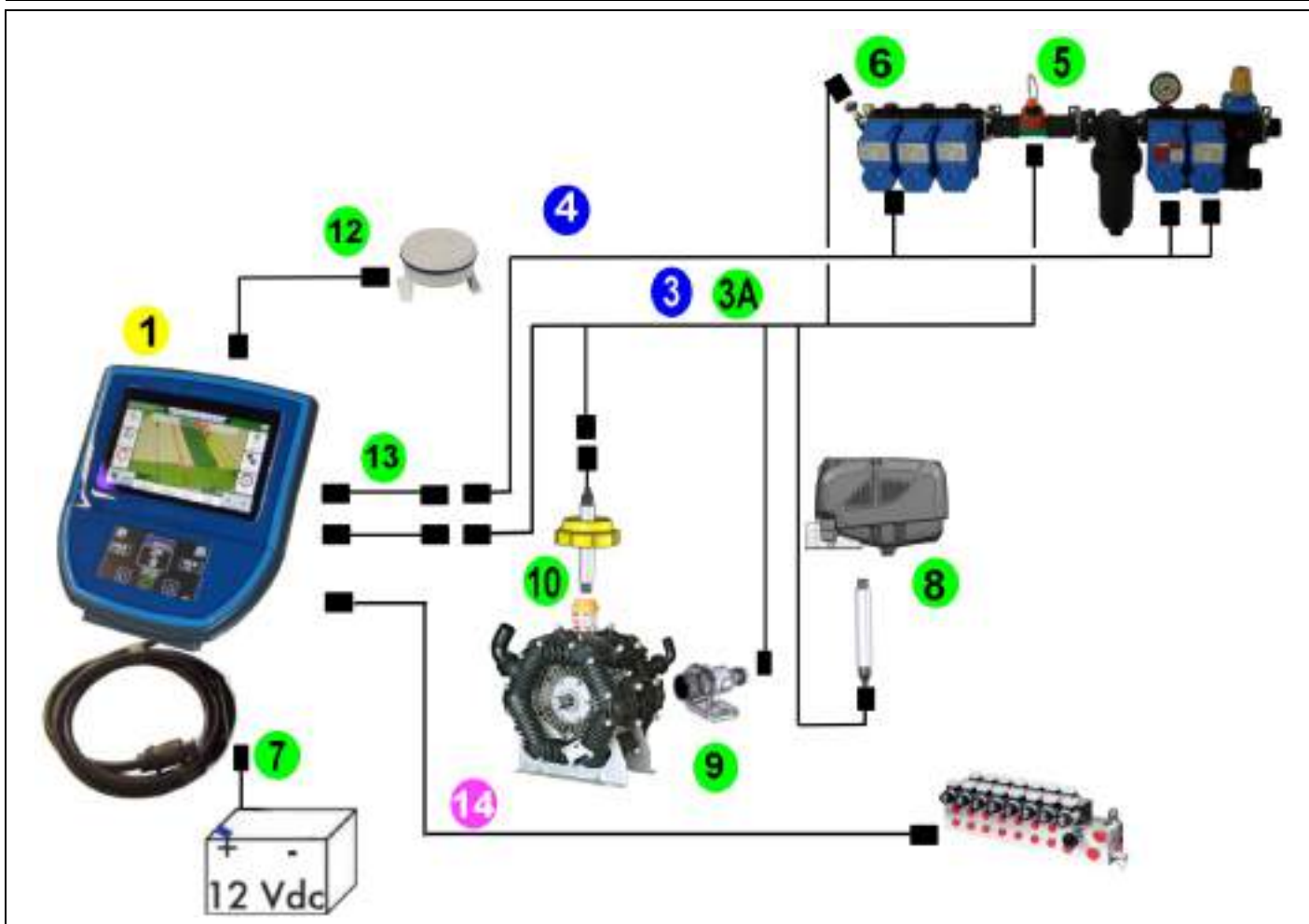

OPTIONALS WSC / HYDRAULIC WSC

POS.	DESCRIZIONE DESCRIPTION	Caratteristiche Features	Codice Part Nr.	Prezzo Price
3A	CAVO SENSORI (3A) CABLE TO SENSORS (3A)	sensore press./pressure sens. 6 - flussometro/ flowmeter 5 - sensore velocità induttivo/inductive speed sensor 11 - RPM 9 - livello olio/oil level 10	828308002	€ 202,50
5	Flussometri Flowmeters	Turbina / Elettromagnetico Turbine / Electromagnetic	Vedi pag. 78 See page 78	
6	Trasduttore di pressione Pressure transducer	0-40Bar 0-100Bar 0-50Bar	Vedi pag. 78 See page 78	
7	Cavo batteria Battery cable	Connettore Cobo tripolare - terminali ad occhio 3 poles connector - Eye terminals	828168002	€ 137,70
8	Sensore di livello cisterna Tank level sensor	Range 0-4Mt - Segnale 4-20mA - Attacco G. 1/4" Range 0-4Mt - Signal 4-20mA - Connection G. 1/4"	Vedi pag. 78 See page. 78	
9	Sensore di giri pompa/ventola Pump RPM/fan sensor	Completo di staffa di supporto With mounting brackets		
10	Sensore di livello olio Oil level sensor	Completo di ghiera per fissaggio al tappo serbatoio With ring nut for fastening to the tank plug		
12	Sensore di velocità Speed sensor	Antenna GPS mod. WSA Sensore induttivo - inductive sensor		
13	Cavo estensioni sensori Extension cable to sensor	L. 8mt.	828507002	€ 264,60
	Cavo estensione Extension cable	L. 4mt.	828108002	€ 168,75

KIT COMPUTER SBSC GPS

TABLET

SBSC T40



CODICE PART NR.	DESCRIZIONE DESCRIPTION	PREZZO PRICE
828510973	Computer SBSC T40 10" comprensivo di: <ul style="list-style-type: none"> • Tablet 10" • Software • Ricevitore e Antenna GPS (precisione +/- 40 cm) • Cavi alimentazione ricevitore/tablet • Staffa di supporto Tablet 	€ 3.067,20

SBSC T20



CODICE PART NR.	DESCRIZIONE DESCRIPTION	PREZZO PRICE
828511973	Computer SBSC T40 10" comprensivo di: <ul style="list-style-type: none"> • Tablet 10" • Software • Ricevitore e Antenna GPS (precisione +/- 20 cm) • Cavi alimentazione ricevitore/tablet • Staffa di supporto Tablet 	€ 4.465,80

COME ORDINARE- HOW TO ORDER

OPTIONAL:

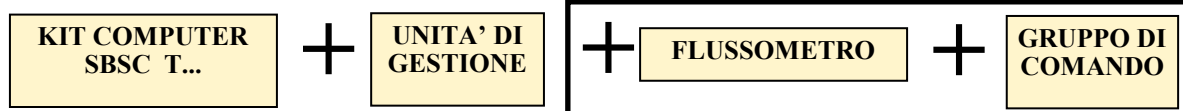

KIT COMPUTER SBSC GPS

DISPLAY

SBSC S40



CODICE PART NR.	DESCRIZIONE DESCRIPTION	PREZZO PRICE
828510973S	Computer SBSC S40 10" comprensivo di: <ul style="list-style-type: none"> • Schermo 10" • Ricevitore integrato con antenna esterna (precisione +/- 40 cm) • Software • Cavo alimentazione pannello • Staffa di supporto 	€ 4.020,30

SBSC S20



CODICE PART NR.	DESCRIZIONE DESCRIPTION	PREZZO PRICE
828511973S	Computer SBSC S40 10" comprensivo di: <ul style="list-style-type: none"> • Schermo 10" • Ricevitore integrato con antenna esterna (precisione +/- 20 cm) • Software • Cavo di alimentazione pannello • Staffa di supporto 	€ 5.401,35

COME ORDINARE-HOW TO ORDER

OPTIONAL:

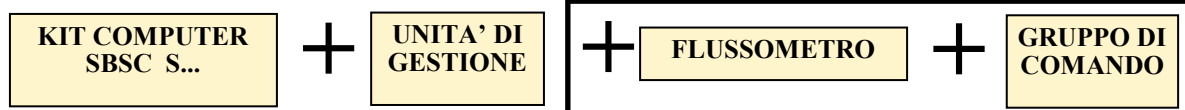

UNITÀ DI GESTIONE BSC-F
(azionamento valvole acqua **3 fili** e collegamento sensori)



- Unità di gestione per controllo valvole VG+VV+VS, controllo per portata, con funzione di chiusura automatica delle sezioni
- Lunghezza cavo alimentazione 6m
- Lunghezza cavi valvole 1,5m
- Lunghezza cavo flussometro 1,5 m
- Lunghezza cavo sensore pressione 3 m
- Trasduttore di pressione incluso, flussometro escluso

CODICE PART NR.	VERSIONE VERSION	PREZZO PRICE
828512973	5 VS	€. 3.843,45
828513973	7 VS	€. 3.910,95
828523973	9 VS	€. 4.050,00
828524973	12 VS	€. 4.255,20

UNITÀ DI GESTIONE BSC-F e UNITÀ DI GESTIONE BSH
(azionamento valvole acqua **3 fili** e collegamento sensori e azionamento valvole idrauliche)



- Unità di gestione per controllo valvole VG+VV+VS, controllo per portata, con funzione di chiusura automatica delle sezioni
- Unità di gestione per controllo valvole oleodinamiche (VO)
- Lunghezza cavo alimentazione 6m
- Lunghezza cavi valvole 1,5m
- Lunghezza cavo flussometro 1,5 m
- Lunghezza cavo sensore pressione 3 m
- Trasduttore di pressione incluso, flussometro escluso

CODICE PART NR.	VERSIONE VERSION	PREZZO PRICE
828514973	5 VS + 7 VO	€. 5.872,50
828515973	7 VS + 7 VO	€. 5.969,70
828528973	7 VS + 9 VO	€. 6.066,90
828529973	9 VS + 9 VO	€. 6.099,30
828530973	9 VS + 12 VO	€. 6.147,90
828531973	12 VS + 9 VO	€. 6.292,35
828532973	12 VS + 12 VO	€. 6.342,30

UNITÀ DI GESTIONE BSC-F
(azionamento valvole acqua **2 fili** e collegamento sensori)



- Unità di gestione per controllo valvole VG+VV+VS, controllo per portata, con funzione di chiusura automatica delle sezioni
- Lunghezza cavo alimentazione 6m
- Lunghezza cavi valvole 1,5m
- Lunghezza cavo flussometro 1,5 m
- Lunghezza cavo sensore pressione 3 m
- Trasduttore di pressione incluso, flussometro escluso

CODICE PART NR.	VERSIONE VERSION	PREZZO PRICE
8285129732F	5 VS	€. 4.490.10
8285139732F	7 VS	€. 4.557.60
8285239732F	9 VS	€. 4.696.65
8285249732F	12 VS	€. 4.901.85

UNITÀ DI GESTIONE BSC-F e UNITÀ DI GESTIONE BSH
(azionamento valvole acqua **2 fili** e collegamento sensori e azionamento valvole idrauliche)



- Unità di gestione per controllo valvole VG+VV+VS, controllo per portata, con funzione di chiusura automatica delle sezioni
- Unità di gestione per controllo valvole oleodinamiche (VO)
- Lunghezza cavo alimentazione 6m
- Lunghezza cavi valvole 1,5m
- Lunghezza cavo flussometro 1,5 m
- Lunghezza cavo sensore pressione 3 m
- Trasduttore di pressione incluso, flussometro escluso

CODICE PART NR.	VERSIONE VERSION	PREZZO PRICE
8285149732F	5 VS + 7 VO	€. 6.519.15
8285159732F	7 VS + 7 VO	€. 6.616.35
8285289732F	7 VS + 9 VO	€. 6.714.90
8285299732F	9 VS + 9 VO	€. 6.745.95
8285309732F	9 VS + 12 VO	€. 6.795.90
8285319732F	12 VS + 9 VO	€. 6.940.35
8285329732F	12 VS + 12 VO	€. 6.988.95

- Software per diserbo e per atomizzatori
- Compatto ed economico
- Display 4.3"
- Touchscreen
- Display personalizzabile
- SD per esportazione dati
- Orchard and boom sprayer software
- Compact and economical
- 4.3 "display
- Touchscreen
- Customizable display
- SD for data export



Configurazione base per il funzionamento del computer. Per optional vedi pag. 71
 Basic configuration for computer operation. For optionals see p. 71

MODELLO MODEL	SEZIONI SECTIONS	CODICE PART NR.	PREZZO PRICE	COMPONENTI COMPONENTS
BUONO Simply	2	828380973	€. 1522.80	1
	3	828381973	€. 1522.80	
	5	828339973	€. 1522.80	
	7	828382973	€. 1522.80	
	9÷13	828503973	€. 1.624,05	
CAVI VALVOLE VALVE CABLES	2	82803510AB	€. 171.72	4
	3	82803610AB	€. 207.50	
	5	828107002B	€. 240.44	
	7	828155002B	€. 324.95	
	9	828495002B	€. 885.60	
	11	828496002B	€. 924.75	
	13	828497002B	€. 973,35	
CAVO SENSORI CABLE TO SENSORS (sensore press./pressure sens. 6 - flussometro/flowmeter 5 - sensore velocità induttivo/inductive speed sensor 11)		828304002	€. 125,55	3
SENSORE DI VELOCITA' INDUTTIVO INDUCTIVE SPEED SENSOR		828212973	€. 95,85	11

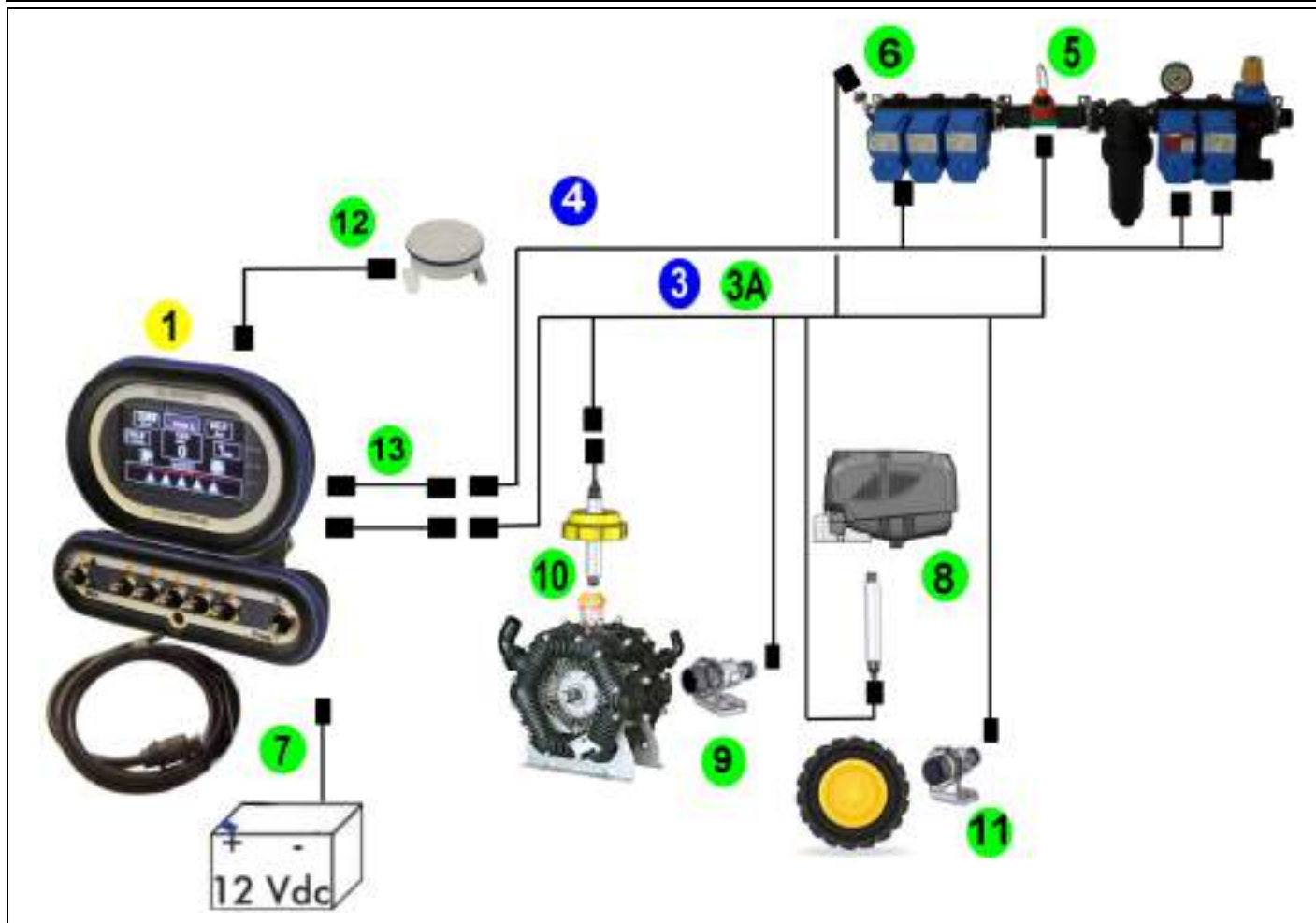

Configurazione base per il funzionamento del computer. Per optional vedi sotto
Basic configuration for computer operation. For optionals see below

MODELLO MODEL	SEZIONI SECTIONS	CODICE PART NR.	PREZZO PRICE	COMPONENTI COMPONENTS
BUONO Simply	2	828380973	€. 1522,80	1
	3	828381973	€. 1522,80	
	5	828339973	€. 1522,80	
	7	828382973	€. 1522,80	
	9+13	828503973	€. 1.624,05	
CAVI VALVOLE VALVE CABLES	2	82803510AB	€. 171,72	4
	3	82803610AB	€. 207,50	
	5	828107002B	€. 240,44	
	7	828155002B	€. 324,95	
	9	828495002B	€. 885,60	
	11	828496002B	€. 924,75	
13	828497002B	€. 973,35		
CAVO SENSORI CABLE TO SENSORS (sensore press./pressure sens. 6 - flussometro/flowmeter 5 – sensore velocità induttivo/inductive speed sensor 11)		828304002	€. 125,55	3
SENSORE DI VELOCITA' INDUTTIVO INDUCTIVE SPEED SENSOR		828212973	€. 95,85	11
CAVO VALVOLE OLEODINAMICHE		828475002 828474002	€. 529,20 €. 618,30	14

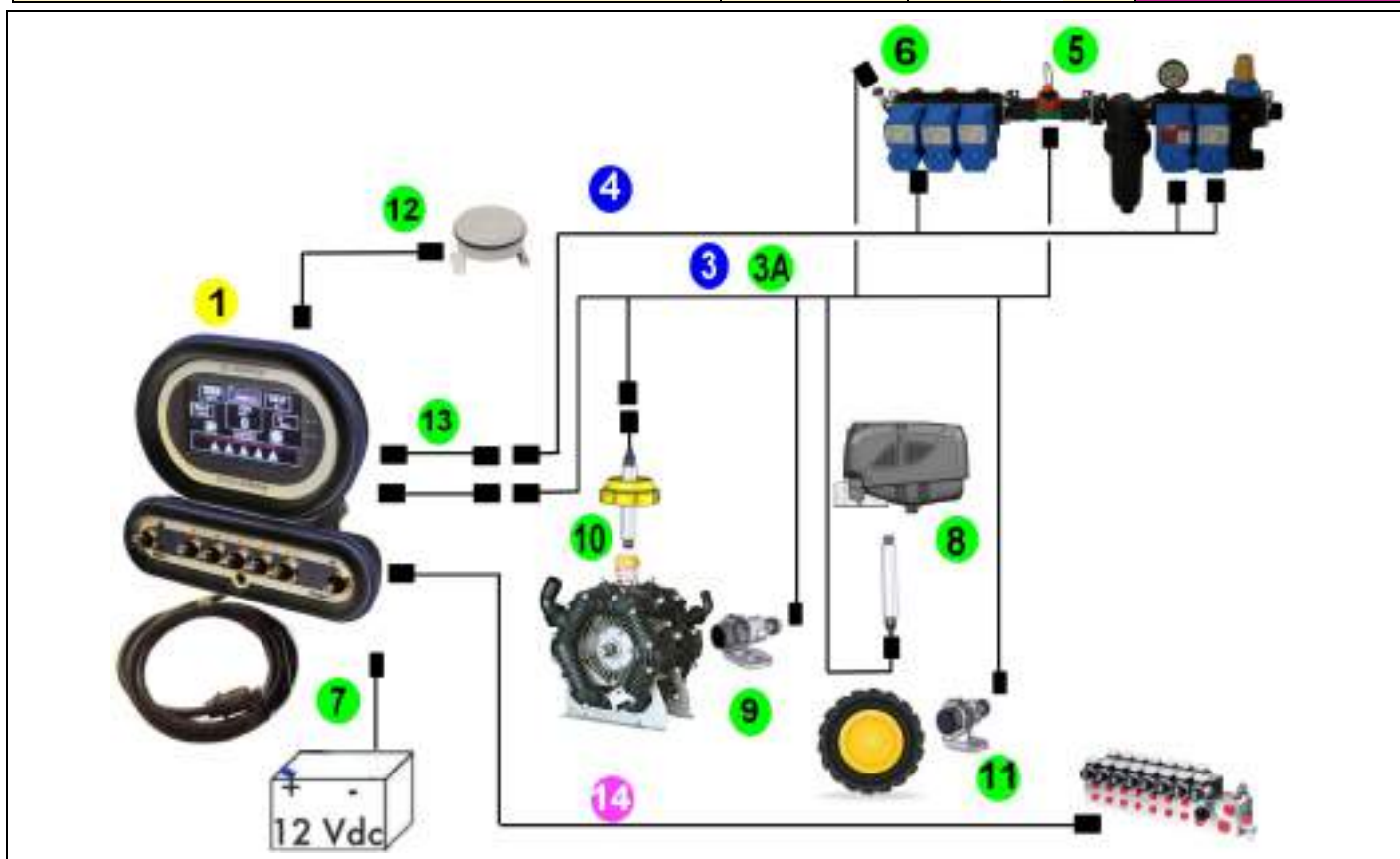



OPTIONALS BUONO Simply / HYDRAULIC BUONO Simply

POS.	DESCRIZIONE DESCRIPTION	Caratteristiche Features	Codice Part Nr.	Prezzo Price
3A	CAVO SENSORI (3A) CABLE TO SENSORS (3A)	sensore press./pressure sens. 6 - flussometro/ flowmeter 5 – sensore velocità induttivo/inductive speed sensor 11 - RPM 9 - livello olio/oil level 10	828308002	€. 202,50
5	Flussometri Flowmeters	Turbina / Elettromagnetico Turbine / Electromagnetic	Vedi pag. 78 See page 78	
6	Trasduttore di pressione Pressure transducer	0-40Bar 0-100Bar 0-50Bar	Vedi pag. 78 See page 78	
7	Cavo batteria Battery cable	Connettore Cobo tripolare – terminali ad occhio 3 poles connector - Eye terminals	828168002	€. 137,70
8	Sensore di livello cisterna Tank level sensor	Range 0-4Mt –Segnale 4-20mA – Attacco G.1/4” Range 0-4Mt –Signal 4-20mA – Connection G.1/4”	Vedi pag. 78 See page. 78	
9	Sensore di giri pompa/ventola Pump RPM/fan sensor	Completo di staffa di supporto With mounting brackets		
10	Sensore di livello olio Oil level sensor	Completo di ghiera per fissaggio al tappo serbatoio With ring nut for fastening to the tank plug		
12	Sensore di velocità Speed sensor	Antenna GPS mod. WSA Sensore induttivo—inductive sensor		
13	Cavo estensioni sensori Extension cable to sensor	L. 8mt.	828507002	€. 264,60
	Cavo estensione Extension cable	L. 4mt.	828108002	€. 168,75

	CONFIGURAZIONE CONFIGURATION	CODICE PART NR.	PREZZO PRICE	CAVO DI ESTENSIONE 3 MT EXTENSION CABLE 3M		
	1 VS/VG	828225973	€ 203,85	VIE SWITCHES	CODICE PART NR.	PREZZO PRICE
	VG + 2VS	828034973	€ 349,65	VG+VV+2VS	828065102	€ 114,75
	2VS	828070973	€ 340,20			
	VG + VV	828069973	€ 286,20			
	VG + VV + 2VS	828035973	€ 388,80			
	VG + VV + 3VS	828036973	€ 430,65			

PANEL CONTROL				CAVO DI ESTENSIONE 4 MT EXTENSION CABLE 4 M	
	CONFIGURAZIONE CONFIGURATION	CODICE PART NR.	PREZZO PRICE	CODICE PART NR.	PREZZO PRICE
	VG + VV + 3VS	828352973	€ 337,50	828108002	€ 168,75
	VG + VV + 5VS	828353973	€ 426,60		

PRESSURE PANEL CONTROL					KIT ESTENSIONE 4 MT EXTENSION KIT 4 M	
		CONFIGURAZIONE CONFIGURATION	CODICE PART NR.	PREZZO PRICE	CODICE PART NR.	PREZZO PRICE
	20 BAR	VG + 2VS	828354973	€ 338,85	82806597A	€ 135,00
		VG + VV + 2VS	828355973	€ 341,55		
		VG + VV + 3VS	828356973	€ 360,45		
		VG + VV + 5VS	828357973	€ 452,25		
		VG + VV + 7VS	828468973	€ 490,05		
	40 BAR	VG + 2VS	828358973	€ 338,85		
		VG + VV + 2VS	828359973	€ 341,55		
		VG + VV + 3VS	828360973	€ 360,45		
		VG + VV + 5VS	828361973	€ 452,25		
		VG+VV+7VS	828455973	€ 490,05		

KIT CAVO DI COLLEGAMENTO VALVOLE PER PANEL CONTROL E PRESSURE PANEL CONTROL CABLE KIT FOR VALVES CONNECTION FOR PANEL CONTROL AND PRESSURE PANEL CONTROL					
		CODICE PART NR.	MT	INCHES	PREZZO PRICE
	VG + 2VS	828034102B	4	157,5	€ 171,72
	VG + VV + 2VS	82803510AB	4	157,5	€ 171,72
	VG + VV + 3VS	82803610AB	4	157,5	€ 207,50
	VG + VV + 5VS	828107002B	4	157,5	€ 240,44
	VG+VV+7VS	828155002B	4	157,5	€ 324,95

PANEL CONTROL

	CONFIGURAZIONE CONFIGURATION	OIL PANEL CONTROL CODICE PART NR.	PREZZO PRICE	CAVO VALVOLE CABLE KIT TO VALVES CODICE - PART NR.	PREZZO PRICE
	VG + VV + 9VS	828494973	€ 564,30	828495002B	€ 885,60

HYDRAULIC PANEL CONTROL

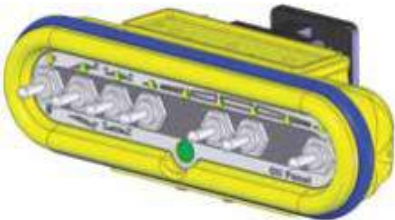

	CONFIGURAZIONE CONFIGURATION	OIL PANEL CONTROL CODICE PART NR.	PREZZO PRICE	CAVO VALVOLE CABLE KIT TO VALVES CODICE - PART NR.	PREZZO PRICE
	VG + VV + 7VS	828473973	€ 494,10	828475002	€ 529,20
VG + VV + 9VS	828472973	€ 531,90	828474002	€ 618,30	

MANOMETRO ANALOGICO
ANALOGUE PRESSURE GAUGE

	PRESSIONE PRESSURE	OIL PANEL CONTROL CODICE PART NR.	PREZZO PRICE
	0-20 BAR 0-290 PSI	828435973	€ 45,90
0-60 BAR 0-870 PSI	828436973	€ 45,90	

	ANTENNA WSA	
	CODICE PART NR.	PREZZO PRICE
	828461973	€. 499,50

	SENSORE INDUTTIVO DI VELOCITA' E DI GIRI SPEED AND RPM INDUCTIVE SENSOR	
	CODICE PART NR.	PREZZO PRICE
	828212973	€. 95,85

FLUSSOMETRI FLOW METERS				
 	FLUSSOMETRO A TURBINA TURBINE FLOW METER			
	ATTACCO THREAD	CARATTERISTICHE FEATURES	CODICE PART NR.	PREZZO PRICE
	T5	10÷100 L/MIN 20 BAR	828500973T5	€. 587,25
	T5	35÷350 L/MIN 20 BAR	828501973T5	€. 650,70
	G. 3/4"	10÷100 L/MIN 50 BAR	828509973	€. 587,25
	FLUSSOMETRO ELETTROMAGNETICO ELECTROMAGNETIC FLOW METER			
	T5	10÷200 L/MIN 20 BAR	828502973T5	€. 992,25
	G. 3/4" F	30÷60 L/MIN 50 BAR	828300973	€. 986,85
	G. 1"1/4 F	30÷60 L/MIN 50 BAR	828299973	€. 986,85

TRASDUTTORI DI PRESSIONE PRESSURE SENSORS				
	CARATTERISTICHE FEATURES		CODICE PART NR.	PREZZO PRICE
	20 BAR (MAX)		827765202	€. 224,10
	40 BAR (MAX)		827765302	€. 224,10
	50 BAR (MAX)		827765602	€. 224,10

	SENSORE DI LIVELLO OLIO OIL LEVEL SENSOR	
	CODICE PART NR.	PREZZO PRICE
	828013002	€. 136,35

	SENSORE LIVELLO CISTERNA TANK LEVEL SENSOR	
	CODICE PART NR.	PREZZO PRICE
	828315002	€. 696,60

VALVOLE DI MASSIMA PRESSIONE - PRESSURE RELIEF VALVES



Mod.	Color	Bar	PSI	L/min	USGPM	By-pass	Cod. - Part Nr.	Prezzo-Price
VS 20	Yellow	20	290	180	47.5	GAS	259708973	€. 89,10
VS 40	Green	40	580	150	39.6	1"1/4	259709973	€. 89,10
VS20	Yellow	20	290	300	80	GAS	245024973	€. 143,10
	Green	40	580	220	58	1"1/4	245025973	€. 143,10

143,10



VALVOLE GENERALI - MAIN VALVES



VGM

VGE

Mod.	Colore Color	Pressure		Flow		By-pass	Pressure	A	Flow	Cod. Part Nr.	Prezzo Price
		Bar	PSI	L/min	USGPM						
VGM	Red	20	290	70	18.5	GAS 1"	/	/	/	258120973	€. 32,40
VGE	Red	40	580				12VDC±2	0.6	5	258650973	€. 182,25
VGE	Red						12VDC±2	0.6	5	258650973HP	€. 209,25

VALVOLE DI REGOLAZIONE PRESSIONE PROPORZIONALE -
PROPORTIONAL PRESSURE REGULATING VALVES



VPBPM

VPBPE

Mod.	Colore Color	Pressure		Flow		By-pass	Pressure	A	Flow	Cod. Part Nr.	Prezzo Price
		Bar	PSI	L/min	USGPM						
VPBPM	Blue	20	290	160	42	GAS 1"	/	/	/	245431973	€. 60,75
VPBPE	Green						12VDC±2	0.2	5	258651973	€. 217,35
	Blue						12VDC±2	0.2	9	258652973	€. 238,95
	Green	21	258653973	€. 238,95							
VPBPE	Green	40	580	12VDC±2	0.2	5	258651973HP	€. 244,35			
	Blue					9	258652973HP	€. 263,25			
	Green					21	258653973HP	€. 263,25			

VALVOLE DI SEZIONE (SEMPLICE EFFETTO) - SECTION VALVES (SIMPLE ACTING)

RS



Mod.	Colore Color						A		Cod. Part Nr.	Prezzo Price
		Bar	PSI	L/min	USGPM					
RSM		20	290	60	16	/	/	/	259803973	€ 32,40
									259804973	€ 32,40
RSE	/	40	580			12VDC±2	0.2	3	258654973	€ 182,25
RSE	/								258654973HP	€ 217,35

VALVOLE DI SEZIONE (DOPPIO EFFETTO) - METERED BY-PASS SECTION VALVES

RD



Mod.	Colore Color						A		Cod. Part Nr.	Prezzo Price
		Bar	PSI	L/min	USGPM					
Versione intermedia - Modular version										
RDM		20	290	60	16	/	/	/	25980597A	€ 70,20
									25980697A	€ 71,55
RDE		40	580			12VDC±2	0.2	3	258656973	€ 209,25
RDE									258655973	€ 209,25
RDE						12VDC±2	0.2	3	258655973HP	€ 233,55
Versione terminale - Threaded outlet for coupling to teh by-pass hose fitting										
RDM		20	290	60	16	/	/	/	25809997A	€ 76,95
									25812197A	€ 75,60
RDE		40	580			12VDC±2	0.2	3	258658973	€ 214,65
RDE									258657973	€ 214,65
RDE						12VDC±2	0.2	3	258657973HP	€ 240,30

VALVOLE GENERALI - MAIN VALVES



VGE (ELETTRICA)

						A		Codice - Part Nr.	Prezzo - Price
Bar	PSI	L/min	USGPM						
20	290	300	79.2	GAS 1"1/4	12VDC±2	1.5	0.5	245630973	€. 324,00
40	580	450	120					245631973	€. 373,95

VALVOLE DI REGOLAZIONE PRESSIONE - PRESSURE REGULATING VALVES



VVE (ELETTRICA)

						A		Codice - Part Nr.	Prezzo - Price
Bar	PSI	L/min	USGPM						
20	290	120	31.7	GAS 1"1/4	12VDC±2	0.6	7	245632973	€. 469,80
							13	245633973	€. 469,80
							30	245634973	€. 469,80
40	580	120	26				7	245635973	€. 504,90
							13	245636973	€. 504,90
							30	245637973	€. 504,90

VALVOLA DI SEZIONE (semplice effetto) - SECTION VALVES (simple acting)

RS



RSE

						A		Codice - Part Nr.	Prezzo - Price
Bar	PSI	L/min	USGPM						
20	290	120	32	▲	12VDC±2	1.5	0.5	245638973	€. 319,95
		200	52	GAS 1"1/4				245639973	€. 322,65
		120	32	GAS 1/2"				245640973	€. 373,95
40	580	120	32	GAS 1/2"					

VALVOLA DI SEZIONE (semplice effetto) - SECTION VALVES (simple acting)

RD



RDE

RD							A		Codice - Part Nr.	Prezzo - Price
	Bar	PSI	L/min	USGPM						
INT	20	290	120	32	▲	12VDC±2	1.5	0.5	245641973	€. 378,00
			200	52	GAS 1"1/4				245642973	€. 380,70
	40	580	120	32	GAS 1/2"				245643973	€. 442,80
TERM.	20	290	120	32	▲				245644973	€. 371,25
			200	52	GAS 1"1/4				245645973	€. 376,65
	40	580	120	32	GAS 1/2"				245646973	€. 437,40

20
BAR

CONTROL UNITS

160 L/MIN

BERTOLINI
pumps**SU RICHIESTA (NO T5)**
ON REQUEST (NO T5)**DISTRIBUTORI MANUALI E MOTORIZZATI - MANUAL AND MOTOR POWERED CONTROL UNITS**

BASSA PRESSIONE LOW PRESSURE	CONFIGURAZIONE CONFIGURATION	CODICE PART NR.	PREZZO PRICE
	ECOCONTROL VGM + VPBPM + RSM		
	3 RSM	25832797A	€. 292,95
	4 RSM	25832897A	€. 315,90
	5 RSM	25832997A	€. 338,85
	ECOCONTROL VGM + RSM		
	3 RSM	258433973	€. 233,55
	4 RSM	258434973	€. 259,20
	5 RSM	258435973	€. 279,45
	ECOCONTROL VGM + VPBPM + RDM		
	3 RDM	25814397A	€. 380,70
	4 RDM	25827297A	€. 432,00
	5 RDM	25828397A	€. 488,70
	ECOCONTROL VGM + RDM		
	3 RDM	258436973	€. 324,00
	4 RDM	258437973	€. 376,65
5 RDM	258438973	€. 427,95	
ECOCONTROL VGE + VPBPE + RSE			
3 RSE	25833097A	€. 1.274,40	
4 RSE	25833197A	€. 1.479,60	
5 RSE	25833297A	€. 1.688,85	
ECOCONTROL VGE + VPBPE + RDE			
3 RDE	25813397B	€. 1.351,35	
4 RDE	25827197B	€. 1.582,20	
5 RDE	25824097B	€. 1.814,40	
ECOCONTROL VGE + RDE			
2 RDE	258388973	€. 880,20	
4 RDE	258389973	€. 1.340,55	

KIT RACCORDI INGRESSO E BY PASS GRUPPI DI REGOLAZIONE ECOCONTROL
INLET AND BYPASS PIPE FITTINGS KITS FOR ECOCONTROL CONTROL UNITS

KIT RACCORDI IN E BY-PASS MM. 25 G 1" 1/4 F INLET AND OUTLET PIPE FITTINGS MM. 25 G 1" 1/4 F	253047973	€. 14,85
KIT RACCORDI IN E BY-PASS MM. 25 (90°) G 1" 1/4 F INLET AND OUTLET PIPE FITTINGS MM. 25 (90°) G 1" 1/4 F	253045973	€. 16,20
KIT RACCORDI IN E BY-PASS MM. 30 G 1" 1/4 F INLET AND OUTLET PIPE FITTINGS MM. 30 G 1" 1/4 F	253048973	€. 14,85
KIT RACCORDI IN E BY-PASS MM. 30 (90°) G 1" 1/4 F INLET AND OUTLET PIPE FITTINGS MM. 30 (90°) G 1" 1/4 F	253046973	€. 16,20

KIT PORTAGOMMA USCITA VALVOLE DI SEZIONE VEDI PAG. 44 - HOSETAIL KITS FOR SECTION VALVES SEE PAGE 44

20
BAR

CONTROL UNITS

200 L/MIN

BERTOLINI
pumpsSU RICHIESTA (NO T5)
ON REQUEST (NO T5)**DISTRIBUTORI MANUALI
MANUAL CONTROL UNITS**

CONFIGURAZIONE CONFIGURATION	CODICE PART NR.	PREZZO PRICE
MULTICONTROL VGM + RSM		
2 RSM	251399973	€. 209,25
3 RSM	251400973	€. 234,90
4 RSM	251401973	€. 260,55
5 RSM	251402973	€. 284,85
6 RSM	251403973	€. 309,15
MULTICONTROL VGM + RSM + FILTRO (FILTER)		
3 RSM	258340973	€. 352,35
4 RSM	258189973	€. 375,30
6 RSM	258256973	€. 421,20
MULTICONTROL VGM + RDM		
2 RDM	25139897A	€. 311,85
3 RDM	25140597A	€. 371,25
4 RDM	25140697A	€. 406,35
5 RDM	25140797A	€. 433,35
6 RDM	25140897A	€. 465,75
7 RDM	25140997A	€. 504,90
MULTICONTROL VGM + VPBPM + RSM		
3 RDM	25141097B	€. 432,00
4 RDM	25141197B	€. 481,95
5 RDM	25141297B	€. 508,95

**DISTRIBUTORI MOTORIZZATI
MOTOR POWERED CONTROL UNITS**

CONFIGURAZIONE CONFIGURATION	CODICE PART NR.	PREZZO PRICE
MULTICONTROL VGE + RSE		
3 RSE	258289973	€. 1.069,20
4 RSE	258290973	€. 1.273,05
5 RSE	258291973	€. 1.482,30
MULTICONTROL VGE + VPBPE (9 sec) + RSE		
3 RSE	258337973	€. 1.313,55
4 RSE	258338973	€. 1.521,45
5 RSE	258339973	€. 1.726,65
MULTICONTROL VGE + RDE		
3 RDE	25150597B	€. 1.140,75
4 RDE	25150697B	€. 1.364,85
5 RDE	25150797B	€. 1.591,65
MULTICONTROL VGE + VPBPE (9 sec) + RDE		
3 RDE	25813497A	€. 1.370,25
4 RDE	25817097A	€. 1.597,05
5 RDE	25817197A	€. 1.821,15

**KIT RACCORDI INGRESSO E BY-PASS DISTRIBUTORI E GRUPPI DI REGOLAZIONE -
CONTROL UNITS AND REGULATING UNITS INLET AND OUTLET PIPE FITTINGS KITS**

	DESCRIZIONE DESCRIPTION	CODICE PART NR.	PREZZO PRICE
	KIT RACCORDI IN E BY-PASS D.19-25 (90°) INLET AND OUTLET PIPE FITTINGS D. 19-25 (90°)	251925973	€. 16,20
	KIT RACCORDI IN E BY-PASS D.19 (90°)-25 (90°) INLET AND OUTLET PIPE FITTINGS D. 19 (90°) - D. 25 (90°)	251926973	€. 17,55
	KIT RACCORDI IN E BY-PASS D.25-25 (90°) INLET AND OUTLET PIPE FITTINGS D. 25-25 (90°)	252525973	€. 18,90
	KIT RACCORDI IN E BY-PASS D.25 (90°)-25 (90°) INLET AND OUTLET PIPE FITTINGS D. 25 (90°) - D. 25 (90°)	252526973	€. 18,90
	KIT RACCORDI IN E BY-PASS D.25-30 (90°) INLET AND OUTLET PIPE FITTINGS D. 25-30 (90°)	252530973	€. 18,90
	KIT RACCORDI IN E BY-PASS D.25 (90°)-30 (90°) INLET AND OUTLET PIPE FITTINGS D. 25 (90°) - D. 30 (90°)	252531973	€. 27,00

KIT PORTAGOMMA USCITA VALVOLE DI SEZIONE VEDI PAG. 44 - HOSETAIL KITS FOR SECTION VALVES SEE PAGE 44

15
BAR

CONTROL UNITS

260 L/MIN



SU RICHIESTA (NO T5)
ON REQUEST (NO T5)

**DISTRIBUTORI MANUALI
MANUAL CONTROL UNITS**



CONFIGURAZIONE CONFIGURATION	CODICE PART NR.	PREZZO PRICE
NERGYDROP VGM + RSM		
3 RSM	258310973	€. 264,60
4 RSM	258311973	€. 288,90
5 RSM	258312973	€. 313,20
NERGYDROP VGM + RDM		
3 RDM	25170097A	€. 380,70
4 RDM	25170197A	€. 442,80
5 RDM	25170297A	€. 502,20

**DISTRIBUTORI MOTORIZZATI
MOTOR POWERED CONTROL UNITS**



NERGYDROP VGE + RSE		
CONFIGURAZIONE CONFIGURATION	CODICE PART NR.	PREZZO PRICE
3 RSE	258301973	€. 1.093,50
4 RSE	258302973	€. 1.300,05
5 RSE	258303973	€. 1.505,25
NERGYDROP VGE + VPBE (9sec) + RSE		
3 RSE	258298973	€. 1.359,45
4 RSE	258299973	€. 1.564,65
5 RSE	258300973	€. 1.800,90

NERGYDROP VGE + RDE		
CONFIGURAZIONE CONFIGURATION	CODICE PART NR.	PREZZO PRICE
3 RDE	258307973	€. 1.165,05
4 RDE	258308973	€. 1.394,55
5 RDE	258309973	€. 1.641,60
NERGYDROP VGE + VPBE (9sec) + RDE		
3 RDE + VPBE	25180097C	€. 1.386,45
4 RDE + VPBE	25180197C	€. 1.621,35
5 RDE + VPBE	25180297C	€. 1.860,30

**KIT RACCORDI INGRESSO E BY-PASS DISTRIBUTORI E GRUPPI DI REGOLAZIONE -
CONTROL UNITS AND REGULATING UNITS INLET AND OUTLET PIPE FITTINGS KITS**



DESCRIZIONE DESCRIPTION		CODICE PART NR.	PREZZO PRICE
KIT RACCORDI IN E BY-PASS + UGELLO INLET AND OUTLET (+NOZZLE) FITTINGS KIT	80-110 LT/MIN	252532973	€. 20,25
KIT RACCORDI IN E BY-PASS + UGELLO INLET AND OUTLET (+NOZZLE) FITTINGS KIT	110-160 LT/MIN	252540973	€. 35,10
KIT RACCORDI IN E BY-PASS + UGELLO INLET AND OUTLET (+NOZZLE) FITTINGS KIT	160-210 LT/MIN	253040973	€. 36,45
KIT RACCORDI IN E BY-PASS + UGELLO INLET AND OUTLET (+NOZZLE) FITTINGS KIT	210-260 LT/MIN	253041973	€. 36,45

KIT PORTAGOMMA USCITA VALVOLE DI SEZIONE VEDI PAG. 44 - HOSETAIL KITS FOR SECTION VALVES SEE PAGE 44

15
BAR

CONTROL UNITS

260 L/MIN

BERTOLINI
pumps

SU RICHIESTA (NO T5)
ON REQUEST (NO T5)

FILL NERGYDROP

MANUAL



MOTOR
POWERED



FILL NERGYDROP + VGM + RDM

CONFIGURAZIONE CONFIGURATION	CODICE PART NR.	PREZZO PRICE
3 RDM	25172097B	€ 477,90
4 RDM	25172197B	€ 534,60
5 RDM	25172297B	€ 591,30

FILL NERGYDROP + VGE + VPBPE (9sec) + RDE

CONFIGURAZIONE CONFIGURATION	CODICE PART NR.	PREZZO PRICE
3RDE	258313973	€ 1.520,10
4 RDE	258314973	€ 1.759,05
5 RDE	258315973	€ 1.973,70
6 RDE	258386973	€ 2.200,50
7 RDE	258387973	€ 2.427,30

MANUAL



MOTOR
POWERED



FILL NERGYDROP + VGM + VPBPS + F. + RDM

CONFIGURAZIONE CONFIGURATION	CODICE PART NR.	PREZZO PRICE
3 RDM	25173097A	€ 607,50
4 RDM	25173197A	€ 626,40
5 RDM	25173297A	€ 685,80

FILL NERGYDROP + VGM + VPBPS + F. + RDE

CONFIGURAZIONE CONFIGURATION	CODICE PART NR.	PREZZO PRICE
3 RDE	258391973	€ 1.661,85
4 RDE	258392973	€ 1.902,15
5 RDE	258393973	€ 2.115,45



ACCESSORI FILL NERGYDROP (ACCESSORIES)

COMPONENTE COMPONENT	CODICE PART NR.	PREZZO PRICE
Kit flussometro—Flowmeter kit	828444973	€ 1.058,40
Kit motoriduttore DIN B - Motor gearbox kit DIN B	25996797B	€ 264,60
Kit pannello di comando Panel control kit (Bertycontrol 1VS/VG)	Vedi Pag. 74 - See Page 74	

KIT RACCORDI INGRESSO E BY-PASS DISTRIBUTORI E GRUPPI DI REGOLAZIONE - CONTROL UNITS AND REGULATING UNITS INLET AND OUTLET PIPE FITTINGS KITS



DESCRIZIONE DESCRIPTION		CODICE PART NR.	PREZZO PRICE
KIT RACCORDI IN E BY-PASS + UGELLO INLET AND OUTLET (+NOZZLE) FITTINGS KIT	80-110 LT/MIN	252533973	€ 32,40
KIT RACCORDI IN E BY-PASS + UGELLO INLET AND OUTLET (+NOZZLE) FITTINGS KIT	110-160 LT/MIN	252540973	€ 35,10
KIT RACCORDI IN E BY-PASS + UGELLO INLET AND OUTLET (+NOZZLE) FITTINGS KIT	160-210 LT/MIN	253040973	€ 36,45
KIT RACCORDI IN E BY-PASS + UGELLO INLET AND OUTLET (+NOZZLE) FITTINGS KIT	210-260 LT/MIN	253041973	€ 36,45

KIT PORTAGOMMA USCITA VALVOLE DI SEZIONE VEDI PAG. 44 - HOSETAIL KITS FOR SECTION VALVES SEE PAGE 44

20
BAR

CONTROL UNITS

300 L/MIN

BERTOLINI
pumpsSU RICHIESTA (NO T5)
ON REQUEST (NO T5)**DISTRIBUTORI VGE + VPBPE 20 BAR MOTORIZZATI**
MOTOR POWERED CONTROL UNITS VGE + VPBPE 20 BAR

CONFIGURAZIONE CONFIGURATION	CODICE PART NR.	PREZZO PRICE
3 RSE	245523973	€. 2.035,80
4 RSE	245524973	€. 2.361,15
5 RSE	245525973	€. 2.686,50

CONFIGURAZIONE CONFIGURATION	CODICE PART NR.	PREZZO PRICE
3 RDE	245058973	€. 2.155,95
4 RDE	245059973	€. 2.506,95
5 RDE	245060973	€. 2.882,25

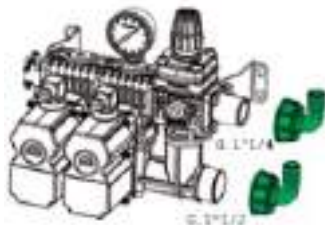
KIT RACCORDI INGRESSO E BY-PASS
INLET AND OUTLET PIPE FITTINGS KITS

GAS	DIAM.	CENTR.	MODELLO MODEL	CODICE PART NR.	PREZZO PRICE
G 1" 1/4	25 MM.	32 MM.	DRITTO - STRAIGHT	253047973	€. 14,85
			CURVO - ELBOW	253045973	€. 16,20
	30 MM.		DRITTO - STRAIGHT	253048973	€. 14,85
			CURVO - ELBOW	253046973	€. 16,20
	32 MM.		DRITTO - STRAIGHT	245342973	€. 16,20
			CURVO - ELBOW	245381973	€. 16,20
G 1" 1/2	25 MM.	38 MM.	DRITTO - STRAIGHT	245343973	€. 14,85
			CURVO - ELBOW	245344973	€. 14,85
	30 MM.		DRITTO - STRAIGHT	245110973	€. 14,85
			CURVO - ELBOW	245111973	€. 16,20
	32 MM.		DRITTO - STRAIGHT	245366973	€. 14,85
			CURVO - ELBOW	245382973	€. 16,20
	35 MM.		DRITTO - STRAIGHT	245367973	€. 16,20
			CURVO - ELBOW	245383973	€. 16,20
	38 MM.		DRITTO - STRAIGHT	245368973	€. 16,20
			CURVO - ELBOW	245384973	€. 16,20
	40 MM.		DRITTO - STRAIGHT	245112973	€. 16,20
			CURVO - ELBOW	245113973	€. 16,20

KIT PORTAGOMMA USCITA VALVOLE DI SEZIONE VEDI PAG. 44 - HOSETAIL KITS FOR SECTION VALVES SEE PAGE 44

GRUPPI SERIE 5 ASSEMBLATI
ASSEMBLED UNITS SERIES-5**ECOCONTROL T5**

- Gruppo regolazione / Regulating unit VGE+VPBPE
- Filtro / Filter 80mesh
- Set valvole di sezione / Section valves assy 5 RDE

258618973T5Euro **1.985,85****ECOCONTROL T5**

- Gruppo regolazione / Regulating unit VGE+VPBPE
- Filtro / Filter 80mesh
- Flussometro T./ Flow meter 10+200
- Set valvole di sezione / Section valves assy 5 RDE

258619973T5Euro **3.126,60****MULTICONTROL T5**

- Gruppo regolazione / Regulating unit VGE+VPBPE
- Filtro / Filter 80mesh
- Set valvole di sezione / Section valves assy 5 RDE

258620973T5**CONSULTAR****MULTICONTROL T5**

- Gruppo regolazione / Regulating unit VGE+VPBPE
- Filtro / Filter 80mesh
- Flussometro T./ Flow meter 10+200
- Set valvole di sezione / Section valves assy 5 RDE

258621973T5Euro **3.437,10****NERGYDROP T5****258622973T5** Euro **2.266,65**

- Gruppo regolaz./Regulating unit VGE+VPBPE
- Filtro / Filter 80mesh
- Set valvole di sez./Section valves assy 5RDE

FILL NERGYDROP T5**258624973T5** Euro **2.164,05**

- Gruppo regolaz./Regulating unit VGE+VPBPE
- Filtro / Filter 80mesh
- Set valvole di sez./Section valves assy 5RDE+ Fill

**NERGYDROP T5****258623973T5** Euro **3.244,05**

- Gruppo regolaz./Regulating unit VGE+VPBPE
- Filtro/ Filter 80mesh
- Flussometro T./ Flow meter 10+200
- Set valvole di sez./Section valves assy 5RDE

FILL NERGYDROP T5**258625973T5** Euro **3.304,80**

- Gruppo regolaz./Regulating unit VGE+VPBPE
- Filtro/ Filter 80mesh
- Flussometro T./ Flow meter 10+200
- Set valvole di sez./Section valves assy 5RDE+ Fill

NOTA: Tutte le configurazioni vanno completate con i relativi raccordi
NOTE: All units must be completed by correct fittings

VERSIONI SPECIALI
SPECIAL VERSIONS

MULTICONTROL

CONFIGURAZIONE - CONFIGURATION	CODICE PART NR.	PREZZO PRICE	CONFIGURAZIONE CONFIGURATION	CODICE PART NR.	PREZZO PRICE
VGE + 3RSE	25150097A	€ 1.046,25	VGM + 7RSM	251404973	€ 345,60
VGE + 4RSE	25150197A	€ 1.247,40			
VGE + 5RSE	25150297A	€ 1.453,95			

NERGYDROP

CONFIGURAZIONE - CONFIGURATION	CODICE PART NR.	PREZZO PRICE	CONFIGURAZIONE CONFIGURATION	CODICE PART NR.	PREZZO PRICE
VGE + VPBPS + 6RDM	25170397A	€ 610,20	VGE + VPBPS + 2RDE	258380973	€ 1.089,45
VGE + VPBPS + 7RDM	25170497A	€ 688,50	VGE + VPBPS + 4RDE	258381973	€ 1.547,10
VGE + VPBPE + 7RDE	25180497C	€ 2.331,45			

FILL NERGYDROP

VGM + VPBPS + 2RDM	258382973	€ 438,75	VGM + VPBPS + 6RDM	25172397A	€ 492,75
--------------------	-----------	----------	--------------------	-----------	----------

VIKING LP

VGE + VPBPE + 2RSE	245340973	€ 1.736,10	VPBPE + 3RDE	245065973	€ 1.823,85
VGE + VPBPE + 2RDE	245179973	€ 1.810,35	VPBPE + 4RDE	245066973	€ 2.197,80
VGE + VPBPE + 6RDE	245061973	€ 3.289,95	VPBPE + 5RDE	245067973	€ 2.569,05
VGE + VPBPE + 7RDE	245062973	€ 3.662,55	VPBPE + 6RDE	245068973	€ 2.941,65
			VPBPE + 37RDE	245069973	€ 3.312,90

VIKING HP

4RSE	245419973	€ 1.848,15	VGE + 2RSE	245423973	€ 1.498,50
4RDE	245422973	€ 2.100,60	VGE + 3RSE	245424973	€ 1.876,50
VPAPE + 2RSE	245432973	€ 1.593,00	VGE + 4RSE	245425973	€ 2.253,15
VPAPE + 2RDE	245435973	€ 1.669,95	VGE + 2RDE	245464973	€ 1.641,60
VPAPE + 3RDE	245436973	€ 2.096,55	VGE + 3RDE	245427973	€ 2.062,80
VPAPE + 4RDE	245437973	€ 2.531,25	VGE + 4RDE	245428973	€ 2.504,25

SET VALVOLE PER PREMIXER
VALVES ASSY FOR PRE-MIXER

CONFIGURAZIONE CONFIGURATION	INGRESSO INLET	CODICE PART NR.	PREZZO PRICE
2 RSM	G. 1" FEMMINA G.1" FEMALE	258395973	€ 91,80
1 RSM + 1 RSM (NC)		258396973	€ 90,45
3 RSM		258397973	€ 110,70
2 RSM + 1 RSM (NC)		258398973	€ 108,00

(NC): VALVOLA CON RITORNO AUTOMATICO IN POSIZIONE DI CHIUSURA, SE NON VIENE MANTENUTA APERTA DALL'AZIONE DELL'OPERATORE

(NC): VALVE WITH AUTOMATIC RETURN IN CLOSING POSITION IF THE OPERATOR DOES NOT KEEP IT OPENED

CODICE	TIPO	MISURE	PREZZO
310397992	SCATOLA - CARTON	32x31x33	€ 5,00
310841992	SCATOLA - CARTON	78x34x38	€ 8,00
310895992	SCATOLA - CARTON	55x40x50	€ 9,00
311055992	SCATOLA - CARTON	120x80x50	€ 20,00
311114992	SCATOLA - CARTON	38x32x49	€ 6,00
311117992	SCATOLA - CARTON	38x38x51	€ 7,00
311122992	SCATOLA - CARTON	57x45x30	€ 7,00
311127992	SCATOLA - CARTON	51x28x32	€ 5,00
311128992	SCATOLA - CARTON	17x17x22	€ 3,00
311159992	SCATOLA - CARTON	42x27x35	€ 4,00
311167992	SCATOLA - CARTON	35,5x28,5x20	€ 5,00
311203992	SCATOLA - CARTON	29x23x28	€ 4,00
311205992	SCATOLA - CARTON	45x45x55	€ 4,00
311334992	SCATOLA - CARTON	49x28x33	€ 7,00
311384992	SCATOLA - CARTON	120x80x61	€ 35,00
311433992	SCATOLA - CARTON	96x66x51	€ 15,00
311434992	SCATOLA - CARTON	120x100x29	€ 20,00
311452992	SCATOLA - CARTON	120x100x35	€ 20,00
311453992	SCATOLA - CARTON	80x60x70	€ 12,00
311742992	SCATOLA - CARTON	38x32x39	€ 5,00
311936992	SCATOLA - CARTON	33x26x19	€ 1,80
311937992	SCATOLA - CARTON	27x23x16	€ 2,40
311938992	SCATOLA - CARTON	39x30x20	€ 3,20
311426992	PALLET	100x120	€ 15,00
311430992	PALLET	80x120	€ 15,00
311432992	PALLET	80x60	€ 11,00

NOTA:
I PREZZI SOPRA SONO SOGGETTI ALLA REVISIONE SULLA BASE DEL LISTINO INTERNAZIONALE DEL CARTONE.

NOTE:
ABOVE PRICES ARE SUBJECT TO CHANGE ON THE BASIS OF THE INTERNATIONAL PRICE LIST OF THE CARTON BOXES.

